

infiniium DCA

Agilent 86100B

Wide-Bandwidth Oscilloscope

Quick Start Guide



Agilent Technologies

Notices

© Agilent Technologies, Inc. 2000-2003

No part of this manual may be reproduced in any form or by any means (including electronic storage and retrieval or translation into a foreign language) without prior agreement and written consent from Agilent Technologies, Inc. as governed by United States and international copyright laws.

Manual Part Number

86100-90057

Edition

First edition, April 2003

Printed in USA

Agilent Technologies, Inc.
Lightwave Division
1400 Fountaingrove Parkway
Santa Rosa, CA 95403, USA

Warranty

The material contained in this document is provided “as is,” and is subject to being changed, without notice, in future editions. Further, to the maximum extent permitted by applicable law, Agilent disclaims all warranties, either express or implied, with regard to this manual and any information contained herein, including but not limited to the implied warranties of merchantability and fitness for a particular purpose. Agilent shall not be liable for errors or for incidental or consequential damages in connection with the furnishing, use, or performance of this document or of any information contained herein. Should Agilent and the user have a separate written agreement with warranty terms covering the material in this document that conflict with these terms, the warranty terms in the separate agreement shall control.

Technology Licenses

The hardware and/or software described in this document are furnished under a license and may be used or copied only in accordance with the terms of such license.

Restricted Rights Legend

If software is for use in the performance of a U.S. Government prime contract or subcontract, Software is delivered and licensed as “Commercial computer software” as defined in DFAR 252.227-7014 (June 1995), or as a “commercial item” as defined in FAR 2.101(a) or as “Restricted computer software” as defined in FAR 52.227-19 (June 1987) or any equivalent agency regulation or contract clause. Use, duplication or disclosure of Software is subject to Agilent Technologies’ standard commercial license terms, and non-DOD Departments and Agencies of the U.S. Government will receive no greater than Restricted Rights as defined in FAR 52.227-19(c)(1-2) (June 1987). U.S. Government users will receive no greater than Limited Rights as defined in FAR 52.227-14 (June 1987) or DFAR 252.227-7015 (b)(2) (November 1995), as applicable in any technical data.

Safety Notices

CAUTION

Caution denotes a hazard. It calls attention to a procedure which, if not correctly performed or adhered to, could result in damage to or destruction of the product. Do not proceed beyond a caution sign until the indicated conditions are fully understood and met.

WARNING

Warning denotes a hazard. It calls attention to a procedure which, if not correctly performed or adhered to, could result in injury or loss of life. Do not proceed beyond a warning sign until the indicated conditions are fully understood and met.

Contents

1 Setting Up the Infiniium DCA

- Step 1. Inspect the Shipment 1–5
- Step 2. Install any Modules 1–9
- Step 3. Consider Environmental Specifications 1–10
- Step 4. Connect the Keyboard and Mouse (Optional) 1–11
- Step 5. Connect the Line Cord 1–12
- Step 6. Turn on the line power 1–15
- Step 7. Set the time and date 1–17
- Step 8. Connect a Printer 1–18
- Step 9. Calibrate the Touch Screen 1–22
- Step 10. Configure the Instrument on a LAN 1–23
- Step 11. Avoid Costly Repairs 1–24
- Step 12. Perform a Module Calibration 1–26
- Step 13. For More Information 1–29
- Cleaning Connections for Accurate Measurements 1–30
- Returning the Instrument for Service 1–39
- Hard Drive Recovery 1–42
- Agilent Technologies Service Offices 1–43

2 Working in Comfort

3 Using the Infiniium DCA

- Eye/Mask Mode 3–7
- Oscilloscope Mode 3–8
- TDR/TDT Mode 3–9
- Using Plug-in Modules 3–10
- Using the Touch Screen 3–12
- Using the Quick Measure Feature 3–13
- If the Display Goes Blank 3–14
- Hiding and Moving Dialog Boxes 3–15
- Menus 3–16

4 Using the Built-In Information System

- The Infiniium DCA Help Contents 4–3
- Description of the Contents Topics 4–4
- Getting Help While Changing Instrument Settings 4–6
- Learning About Measurements Results 4–7

Contents

Hiding the Help 4-8

Printing the Contents of a Topic 4-9

Selecting the Help Language 4-10

5 Regulatory Information

Compliance with German Noise Requirements 5-2

Compliance with Canadian EMC Requirements 5-2

Declaration of Conformity - Mainframe 5-3

Declaration of Conformity - Plug-in Modules 5-4

Step 1. Inspect the Shipment	1-5
Step 2. Install any Modules	1-9
Step 3. Consider Environmental Specifications	1-10
Step 4. Connect the Keyboard and Mouse (Optional)	1-11
Step 5. Connect the Line Cord	1-12
Step 6. Turn on the line power	1-15
Step 7. Set the time and date	1-17
Step 8. Connect a Printer	1-18
Step 9. Calibrate the Touch Screen	1-22
Step 10. Configure the Instrument on a LAN	1-23
Step 11. Avoid Costly Repairs	1-24
Step 12. Perform a Module Calibration	1-26
Step 13. For More Information	1-29
Cleaning Connections for Accurate Measurements	1-30
Returning the Instrument for Service	1-39
Hard Drive Recovery	1-42
Agilent Technologies Service Offices	1-43

Setting Up the Infiniium DCA

Setting Up the Infiniium DCA

This chapter shows you how to properly set up your Infiniium DCA. Follow the setup steps in the order presented. In addition, you will learn how to use proper optical connection cleaning techniques to avoid *costly* repairs. Lastly, this chapter explains how to return your instrument for service.

General Safety Considerations

This product has been designed and tested in accordance with the standards listed in the Manufacturer's Declaration of Conformity, and has been supplied in a safe condition. The documentation contains information and warnings which must be followed by the user to ensure safe operation and to maintain the product in a safe condition.

Install the instrument according to the enclosure protection provided. This instrument does not protect against the ingress of water. This instrument protects against finger access to hazardous parts within the enclosure.

WARNING If this product is not used as specified, the protection provided by the equipment could be impaired. This product must be used in a normal condition (in which all means for protection are intact) only.

WARNING No operator serviceable parts inside. Refer servicing to qualified service personnel. To prevent electrical shock do not remove covers.

WARNING To prevent electrical shock, disconnect the instrument from mains before cleaning. Use a dry cloth or one slightly dampened with water to clean the external case parts. Do not attempt to clean internally.

CAUTION Do not use too much liquid in cleaning the instrument. Water can enter the front-panel keyboard, damaging sensitive electronic components.









WARNING This is a Safety Class 1 Product (provided with a protective earthing ground incorporated in the power cord). The mains plug shall only be inserted in a socket outlet provided with a protective earth contact. Any interruption of the protective conductor inside or outside of the instrument is likely to make the instrument dangerous. Intentional interruption is prohibited.

CAUTION VENTILATION REQUIREMENTS: When installing the product in a cabinet, the convection into and out of the product must not be restricted. The ambient temperature (outside the cabinet) must be less than the maximum operating temperature of the product by 4° C for every 100 watts dissipated in the cabinet. If the total power dissipated in the cabinet is greater than 800 watts, then forced convection must be used.

CAUTION This product is designed for use in Installation Category II and Pollution Degree 2 per IEC 1010 and 664 respectively.

Installation Category: Installation Categories (overvoltage categories) are determined by the transient overvoltage levels that may be expected. CAT I: Mains isolated. CAT II: Line voltage in appliance and to wall outlet. CAT III: Line voltage behind wall outlet to next level of distribution.

Instrument Markings

-  The instruction manual symbol. The product is marked with this warning symbol when it is necessary for the user to refer to the instructions in the manual.
-  The laser radiation symbol. This warning symbol is marked on products which have a laser output.
-  The AC symbol is used to indicate the required nature of the line module input power.
-  The Standby symbol is used to mark the position of the instrument power line switch.
-  The CE mark is a registered trademark of the European Community.
-  The CSA mark is a registered trademark of the Canadian Standards Association.
-  The C-Tick mark is a registered trademark of the Australian Spectrum Management Agency.
-  ISM1-A This text denotes the instrument is an Industrial Scientific and Medical Group 1 Class A product.

Step 1. Inspect the Shipment

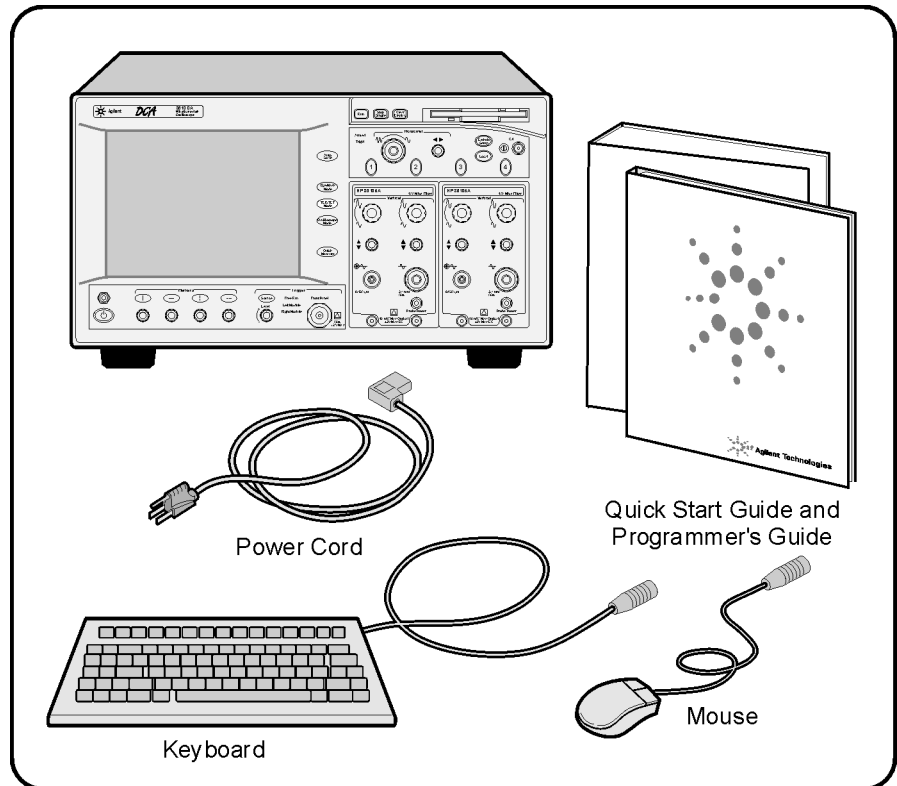

Inspect the shipping container for damage.

Inspect the instrument.

Verify that you received the options and accessories you ordered.

Options and Accessories**NOTE**

Keep the shipping container and cushioning material until you have inspected the contents of the shipment for completeness and have checked the instrument mechanically and electrically.

If anything is missing or defective, contact your nearest Agilent Technologies Sales Office. Refer to [“Agilent Technologies Service Offices” on page 1-43](#). If the shipment was damaged, contact the carrier, then contact the nearest Agilent Sales Office. Keep the shipping materials for the carrier’s inspection. The Agilent Sales Office will arrange for repair or replacement at Agilent’s option without waiting for claim settlement.

Options and Accessories

The following table lists the accessories that may be on the Infiniium DCA shipping list. The information on your actual shipping list is more accurate and should supersede the information in this table.

Table 1-1. Standard Accessories

Accessory	Part Number
Keyboard	1150-7809
Mouse	C3751-60201
Quick Start Guide (this book)	86100-90057
Programmer’s Guide	86100-90058
Filler panel	86101-60005
APC 3.5 (f-f) Adapter/connector saver	5061-5311

The following table lists the available product options. Make sure that you received all of the options that you ordered.

Table 1-2. Instrument Options

Option	Description
001	12 GHz Trigger Bandwidth
AX4	Rack mount flange kit
AXE	Rack mount flange kit with handles
UK6	Commercial calibration certificate with test data







Table 1-3. Optional Accessories

Accessory	Description
10086A	ECL terminator
11667B	Power splitter, dc to 26.5 GHz, APC 3.5 mm
11667C	Power splitter, dc to 50 GHz, 2.4 mm
11898A	Plug-in module remote/extender
11982A	High-speed lightwave receiver
54006A	6 GHz Resistive divider probe kit
54008B	24 ns delay line
54701A	2.5 GHz active probe
83430A	2.5 Gb/s Lightwave transmitter (1550 nm)
83433A	10 Gb/s Lightwave transmitter
83434A	10 Gb/s Lightwave receiver
83440B/C/D	Optical-to-Electrical Converters (6/20/34 GHz)
83446A	Lightwave clock and data receiver
83480A-K16	Switch matrix
83480A-K17	RIMM fixture
N1020A	6 GHz TDR probe kit (passive)
N1022A	Active Probe Adapter
N1025A	1 GHz Active differential probe

Table 1-4. Additional Adapters for Electrical Channels

Adapter	Agilent Part Number
SMA (f-f)	1250-1158
APC 3.5 (f-f)	5061-5311

Options and Accessories**Table 1-5. Fiber-Optic Adapters for Optical Channels**

Front Panel Fiber-Optic Adapter	Description	Agilent Part Number
	Diamond HMS-10	81000AI
	FC/PC	81000FI
	D4	81000GI
	SC	81000KI
	DIN	81000SI
	ST	81000VI
	Biconic	81000WI

Step 2. Install any Modules

Up to two modules can be inserted into the Infiniium DCA. All documentation (including specifications) for plug-in modules is located in the Infiniium DCA's Help system. To access the Help, touch or click **Contents** on the **Help** menu.

- 1 Slide the module into an available front-panel slot.
You can remove or install a module while the instrument is operating.
- 2 Finger tighten the two knurled screws on the module's front panel.

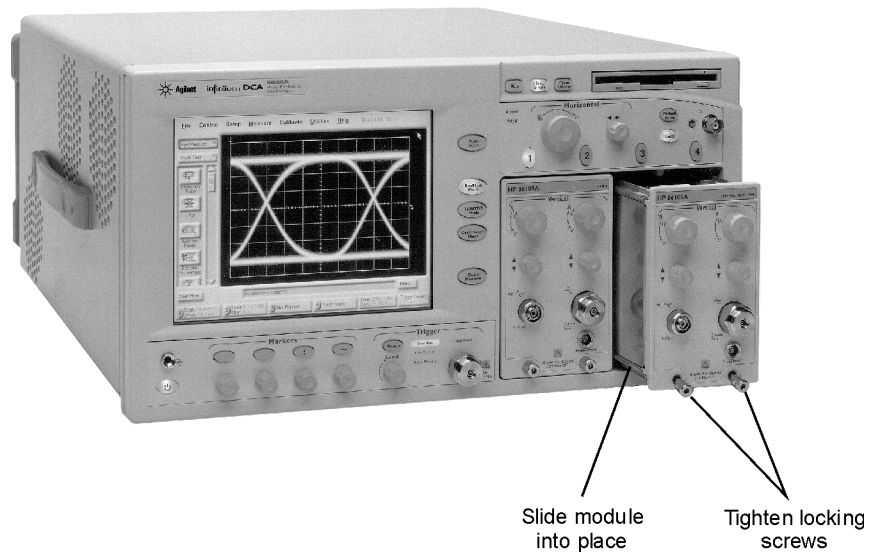

Step 3. Consider Environmental Specifications

Step 3. Consider Environmental Specifications

Review the following specifications to ensure that your operating or storage environment is suitable for the instrument.

Table 1-6. Environmental Specifications

Use	indoor
Temperature	
Operating	10 °C to +40 °C (50 °F to + 104 °F)
Non-operating	-40 °C to +70 °C (-40 °F to +158 °F)
Humidity	
Operating	Up to 90% humidity (non-condensing) at +40 °C (+104 °F)
Non-operating	Up to 95% relative humidity at + 65 °C (+149 °F)
Altitude	
Operating	Up to 4,600 meters (15,000 ft)
Non-operating	Up to 15,300 meters (50,000 ft)
Vibration	
Operating	Random vibration 5-500 Hz, 10 minutes per axis, 2.41 g(rms)
Non-operating	Random vibration 5-500 Hz, 10 minutes per axis, 0.3 g(rms); Resonant search, 5-500Hz swept sine, 1 octave/minute sweep rate, 0.75g, 5 minute resonant dwell at 4 resonances per axis.
Power requirements	
Voltage	90 to 132 or 198 to 264 Vac, 48-66 Hz CAT II
Power (including modules)	545 VA; 375 W
Weight	
Mainframe	15.5 kg (34 lb)
Modules	1.2 kg (2.6 lb)
Dimensions	
Height	215.1 mm (8.47 in)
Width	425.5 mm (16.75 in)
Depth	566 mm (22.2 in)
Depth with front connectors and rear feet	629 mm (24.8 in)

Step 4. Connect the Keyboard and Mouse (Optional)

Connect the standard PC-compatible mouse and keyboard that is supplied with the instrument.

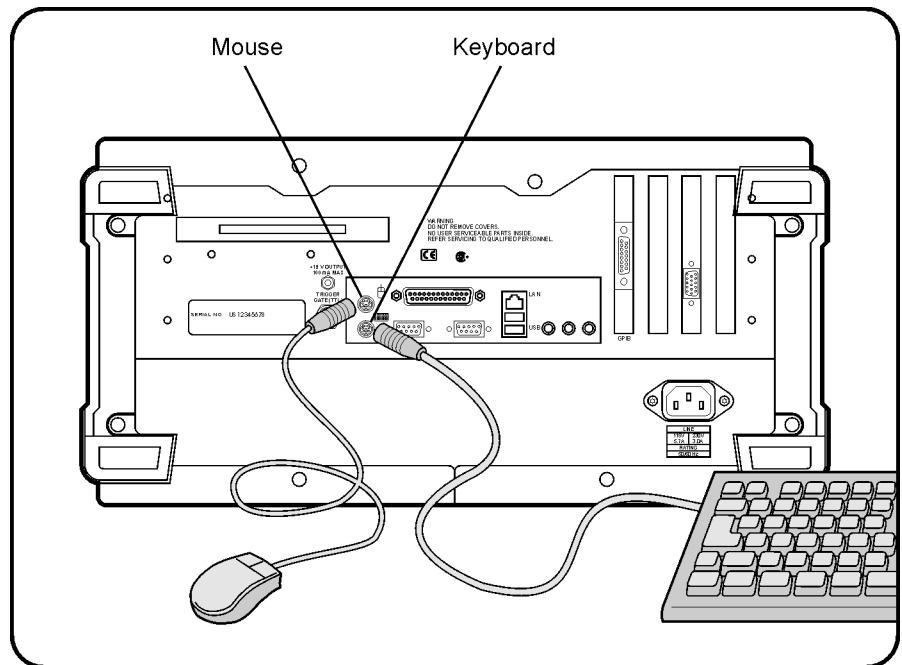

NOTE

Do *not* stack other objects on the keyboard; this will cause self-test failures on power-on.

Step 5. Connect the Line Cord

Connect the line cord as shown in the figure below.

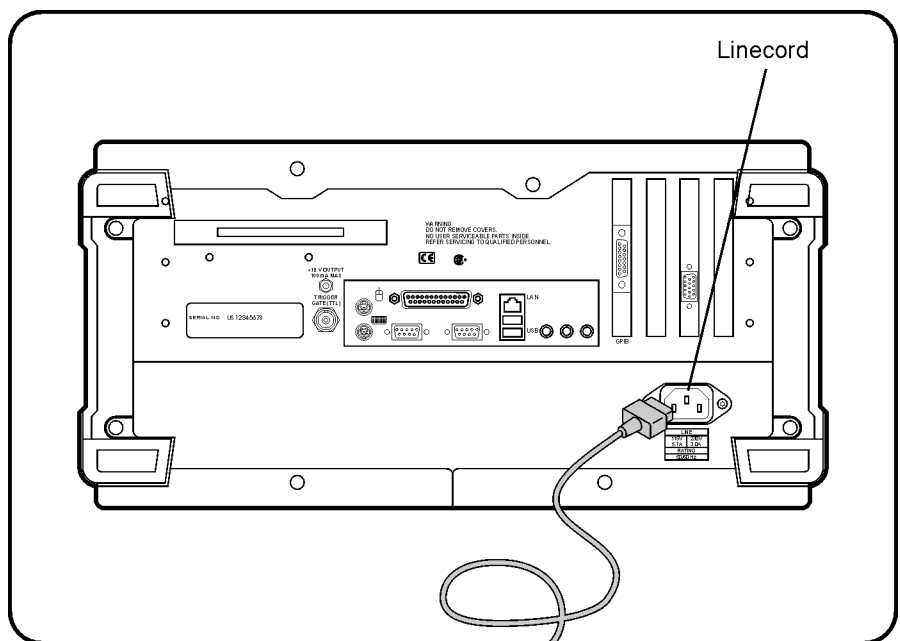

The Infiniium DCA automatically adjusts for line input voltages in the range of 100 to 240 VAC. There is no manual selection switch. The line cord provided is matched by Agilent to the country in which the order originates. Refer to [Table 1-8, “Available Line Cords,” on page 1-13](#) for a list of available line power cords.

Install the instrument so that the detachable power cord is readily identifiable and is easily reached by the operator. The detachable power cord is the instrument disconnecting device. It disconnects the mains circuits from the mains supply before other parts of the instrument. The front panel switch is

only a standby switch and is not a LINE switch. Alternatively, an externally installed switch or circuit breaker (which is readily identifiable and is easily reached by the operator) may be used as a disconnecting device.

CAUTION

Always use the three-prong AC power cord supplied with this instrument. Failure to ensure adequate earth grounding by not using this cord may cause instrument damage.

CAUTION

Do not connect ac power until you have verified the line voltage is correct as described in [Table 1-7](#). Damage to the equipment could result.



CAUTION

This instrument has autoranging line voltage input. Be sure the supply voltage is within the specified range.

Table 1-7. Line Power Requirements





Power	115 VAC: 110 VA MAX. / 60 WATTS MAX. / 1.1 A MAX. 230 VAC: 150 VA MAX. / 70 WATTS MAX. / 0.6 A MAX.
Voltage	nominal: 115 VAC / 230 VAC CAT II range 115 VAC: 90–132 V range 230 VAC: 198–254 V
Frequency	nominals: 50 Hz / 60 Hz range: 47–63 Hz

Table 1-8. Available Line Cords

Plug Type	Cable Part No.	Plug Description	Length (in/cm)	Color	Country
	8120-1351	Straight *BS1363A	90/228	Gray	United Kingdom, Cyprus,
	8120-1703	90°	90/228	Mint Gray	Nigeria, Zimbabwe, Singapore
	8120-1369	Straight *NZSS198/ASC	79/200	Gray	Australia, New Zealand
	8120-0696	90°	87/221	Mint Gray	

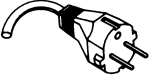
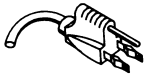
Setting Up the Infiniium DCA
Step 5. Connect the Line Cord

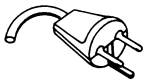
Table 1-8. Available Line Cords

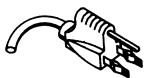
Plug Type	Cable Part No.	Plug Description	Length (in/cm)	Color	Country
	8120-1689	Straight *CEE7-Y11	79/200	Mint Gray	East and West Europe, Saudi Arabia, So. Africa, India (unpolarized in many nations)
	8120-1692	90°	79/200	Mint Gray	
	8120-2857p	Straight (Shielded)	79/200	Coco Brown	
	8120-1378	Straight *NEMA5-15P	90/228	Jade Gray	United States, Canada, Mexico, Philippines, Taiwan
	8120-1521	90°	90/228	Jade Gray	
	8120-1992	Straight (Medical) UL544	96/244	Black	
	8120-2104	Straight *SEV1011	79/200	Mint Gray	Switzerland
	8120-2296	1959-24507 Type 12 90°	79/200	Mint Gray	
	8120-2956	Straight *DHCK107	79/200	Mint Gray	Denmark
	8120-2957	90°	79/200	Mint Gray	
	8120-4211	Straight SABS164	79/200	Jade Gray	Republic of South Africa
	8120-4600	90°	79/200	Jade Gray	India
	8120-4753	Straight MIT1	90/230	Dark Gray	Japan
	8120-4754	90°	90/230	Dark Gray	

* Part number shown for plug is the industry identifier for the plug only. Number shown for cable is the Agilent Technologies part number for the complete cable including the plug.

Step 6. Turn on the line power

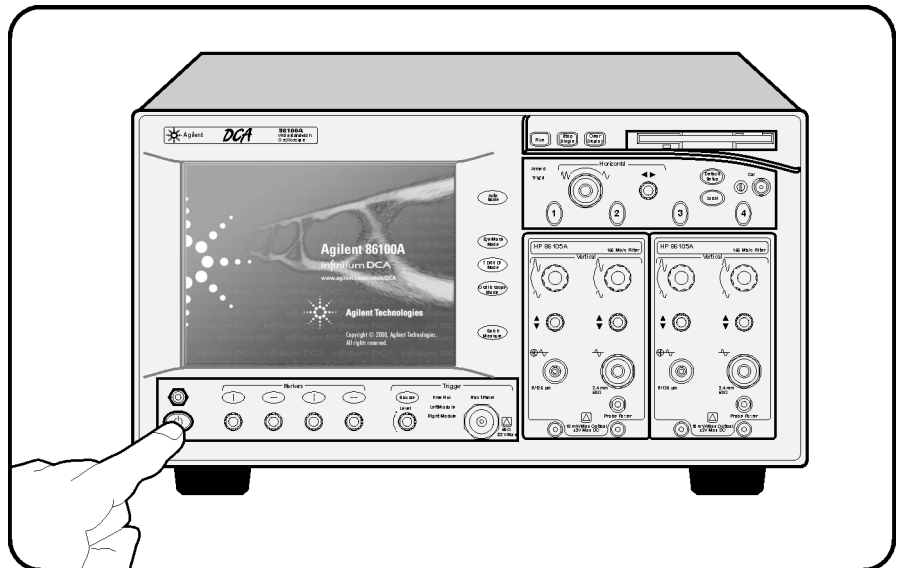

Press the power switch at the lower left-hand corner of the front panel. After about one minute, the Infiniium DCA will be ready to use. The display will look similar to the following figure.

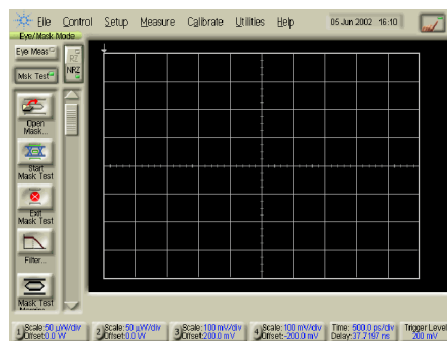

NOTE

The detachable power cord is the instrument disconnecting device. It disconnects the mains circuits from the mains power supply before other parts of the instrument. The front panel switch is only a standby switch and is not a LINE switch disconnecting device.

Install the instrument so that the detachable power cord is readily identifiable and is easily reached by the operator.

Interacting With the Display

Although you can operate all instrument functions using a keyboard and mouse, the touch screen feature makes your Infiniium DCA even easier to use. You can explore the instrument's functions and settings by touching elements on the display (such as menus, buttons, and other controls) with your finger or the supplied stylus.

Although this book uses the term “touch” to encourage you to experience using the touch screen, you can always click using a mouse or PC-compatible pointing device instead.

NOTE

The display will always function as a touch screen, even when a mouse and keyboard are connected.

CAUTION

Avoid touching the screen with a sharp object, as this could result in damage to the display. Use your finger or the supplied stylus.

Step 7. Set the time and date

- 1 Touch the current time and date shown near the top of the display. The **Set Time and Date** dialog box opens.



- 2 Enter the current time and date in one of the following ways:
 - Click the time and date text boxes, and enter the desired number.
 - Click the up or down arrows next to the time and date text boxes until the desired number is displayed.

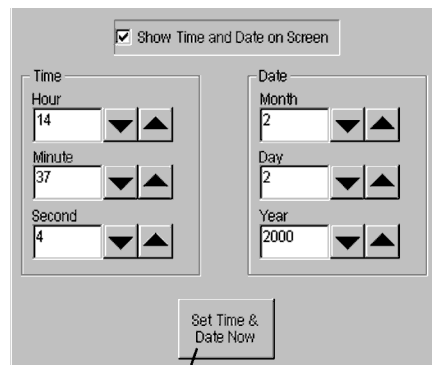

Touch to save settings

- 3 Touch **Set Time & Date Now** to apply the changes and close the dialog box.

Step 8. Connect a Printer

Step 8. Connect a Printer

Use of a printer with the Infiniium DCA is optional. [Table 1-9](#) lists the PCL-language printers that are currently supported for use with the instrument. To add a local printer, you must use the Add Printer Wizard to select the printer driver for the printer as outlined in this procedure; the Add Printer Wizard does not run automatically. For more information on connecting and using a printer, refer to the built-in information system. To add a network printer, contact your network administrator.

Unsupported printers

If your printer is not in the list of supported printers, you will need the printer driver disk that came with your printer. To install the printer driver from this disk, click Have Disk on the Add Printer Wizard dialog box. The instrument will then prompt you to put your printer driver disk into the front-panel disk drive (drive A) or rear-panel CD-Rom drive. Be sure to install the Windows 98 printer driver for your printer. If a printer driver disk was not provided or you cannot find the disk, you can contact the printer's manufacturer to obtain the appropriate Windows 98 printer driver.

Table 1-9. Supported Printers

HP DeskJet 850	HP DeskJet 1600C
HP DeskJet 890C	HP LaserJet 4P
HP DeskJet 970	HP LaserJet 4000N
HP DeskJet 1200C	

To connect a printer

- 1 Turn on the power to the Infiniium DCA.
- 2 On the File menu, select **Print Setup** and then **Add Printer**.

An online Help window opens with instructions for connecting a printer. You do not need to read the displayed instructions at this time.

Step 8. Connect a Printer

- 3 Turn the power off the Infiniium DCA. Do not exit the online Help before turning the instrument off.
- 4 Connect the printer to the instrument's rear-panel **Parallel** port. Refer to ["Rear-panel features" on page 3-6](#) to locate the **Parallel** port. Use the cable that came with your printer.
- 5 Turn the printer power on.
- 6 Wait five seconds and then turn the power on the Infiniium DCA again.
- 7 The following message appears. Touch **No**.

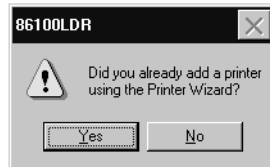

- 8 The following message appears. Touch **OK**.



- 9 The instrument automatically recognizes the printer connected on the printer port and displays the Add Printer Wizard. Touch **Next**.

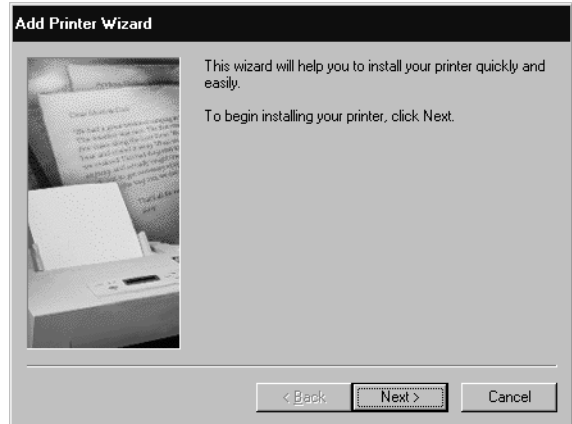

Step 8. Connect a Printer

- 10 Select Local printer and then touch **Next**.

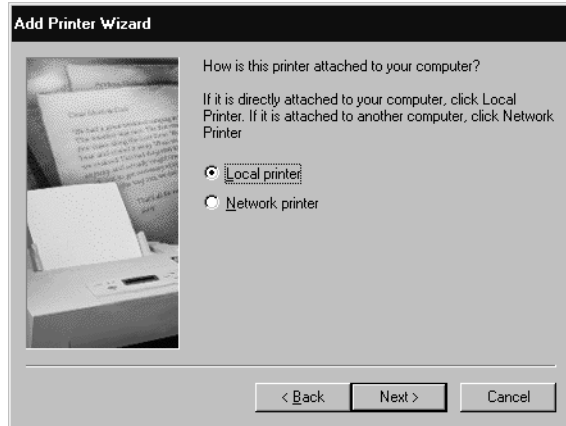

- 11 Select the printer manufacturer and then printer. Then, touch **Next**. If your printer is not listed, touch **Have Disk**. The instrument will then prompt you to put your printer driver disk into the front-panel disk drive (drive A) or CD-Rom drive. Be sure to install the Windows 98 printer driver for your printer.

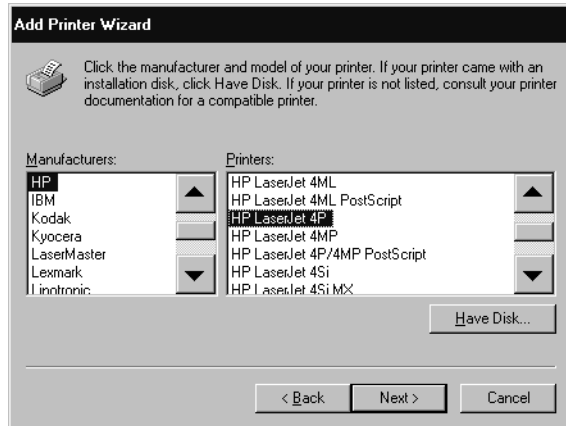

- 12 Select LPT1 for the printer port. Touch **Next**.

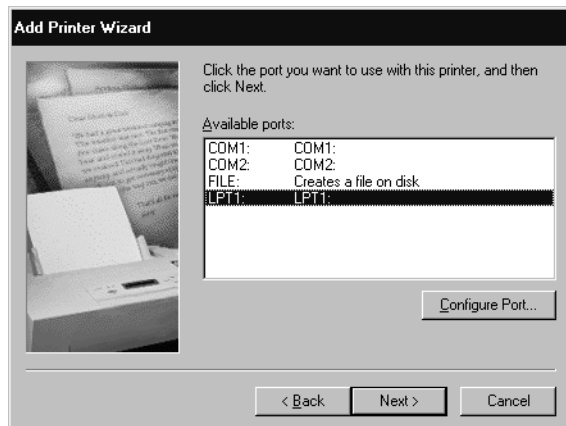

- 13** Touch **Yes** and then touch **Next**.

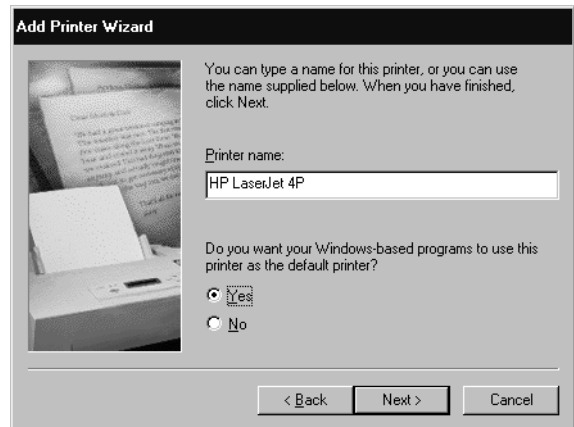

- 14** Touch **Yes** to print a test page. Then, touch **Next**.

- 15** After confirming that the test page printed correctly, touch **Yes**.

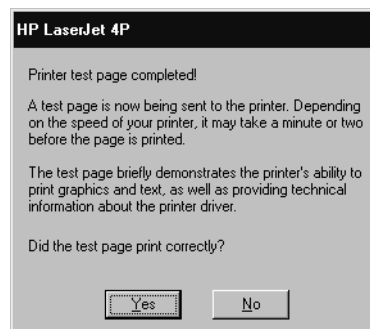
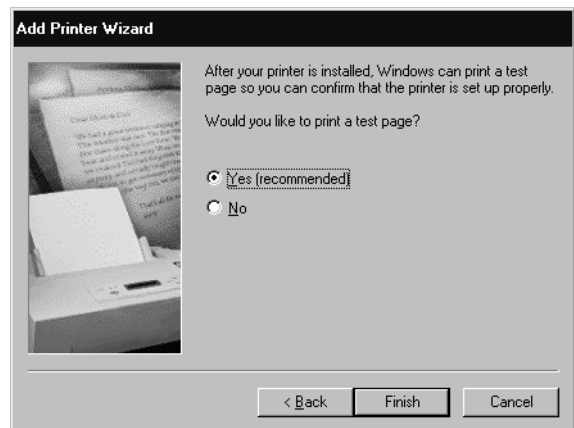

- 16** Turn the Infiniium DCA's power off and then on again. The printer is now installed and ready to use.

Step 9. Calibrate the Touch Screen

The touch screen configuration utility ensures that the touch screen is both aligned and orientated with the display. Therefore, when you touch an element on the display screen, the instrument can detect the task you want to perform.

- 1 On the **Utilities** menu, choose **Touch Screen Calibration**. The touch screen configuration utility opens.

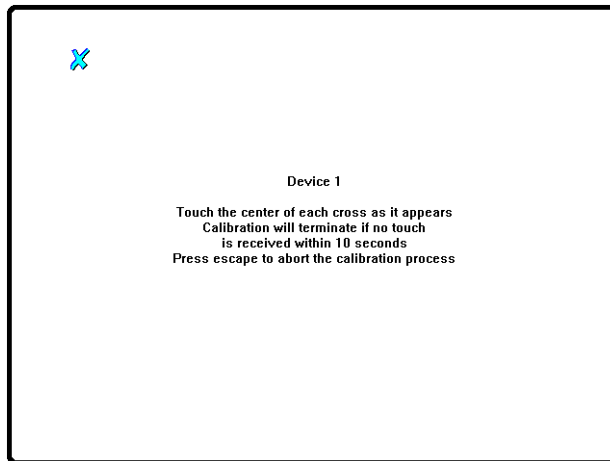

- 2 Touch the center of the **X**. The **X** will move to each corner of the display screen. The final **X** will appear in the center of the display screen. When the display is calibrated, the touch screen configuration utility closes.

The calibration will time out within 10 seconds if you do not touch the center of the X. You can also press **Esc** on an optional keyboard to exit the touch screen calibration.

Step 10. Configure the Instrument on a LAN

You can configure this instrument on a LAN for file sharing and using network printers. Contact your company's network administrator to set up your instrument with the appropriate client, protocol, and configuration for your local area network (LAN). The network setup is different for every company. If you plan on sharing your instrument hard disk drive with other computers on your LAN, you should have the network administrator enable file sharing as part of the network setup. For more information on setting up a network drive, refer to the built-in information system.

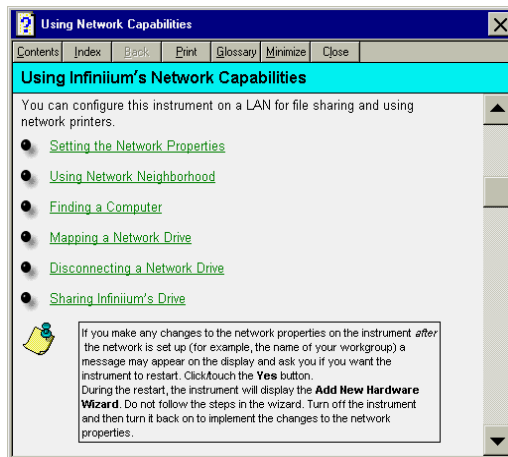

Step 11. Avoid Costly Repairs

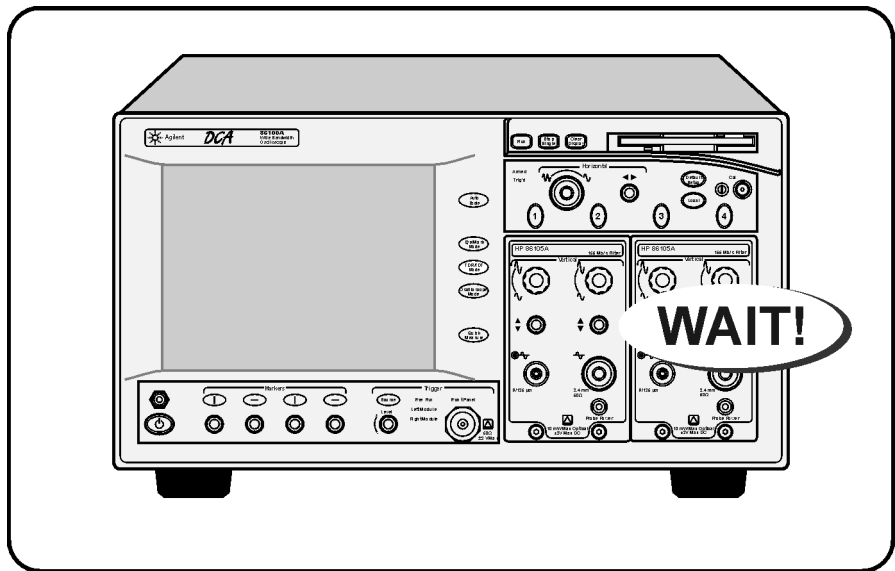

CAUTION

Electrical channel input circuits and the trigger input circuit can be damaged by electrostatic discharge (ESD). Therefore, avoid applying static discharges to the front-panel input connectors. Prior to connecting any coaxial cable to the connectors, momentarily short the center and outer conductors of the cable together. Avoid touching the front-panel input connectors without first touching the frame of the instrument. Be sure that the instrument is properly earth-grounded to prevent buildup of static charge. Wear a wrist-strap or heel-strap.

CAUTION

Optical channel fiber-optic connectors are easily damaged when connected to dirty or damaged cables and accessories. When you use improper cleaning and handling techniques, you risk expensive instrument repairs, damaged cables,

and compromised measurements. Before you connect any fiber-optic cable to the Infiniium DCA, refer to [“Cleaning Connections for Accurate Measurements”](#) on page 1-30.

Step 12. Perform a Module Calibration

A module calibration establishes calibration factors for all installed modules. The calibration factors compensate for imperfections in the measurement system (for example, variations due to ambient temperature), resulting in the best instrument precision. It is recommended that you perform this calibration routinely for best measurement accuracy.

The module calibration is recommended whenever the following occurs:

- Instrument power has been cycled
- A module has been removed and then reinserted
- A change in the temperature of the mainframe exceeds 5°C compared to the temperature of the last vertical (amplitude) calibration ($\Delta T > 5^\circ\text{C}$)
- The time since the last calibration has exceeded 10 hours

Refer to the Help for more information about instrument calibrations.

Warm-up time

Allow the instrument, with modules installed, to warm up for a period of at least one hour before performing a vertical calibration. This ensures that the module reaches its equilibrium temperature.

CAUTION

Electrical channel input circuits and the trigger input circuit can be damaged by electrostatic discharge (ESD). Therefore, avoid applying static discharges to the front-panel input connectors. Prior to connecting any coaxial cable to the connectors, momentarily short the center and outer conductors of the cable together. Avoid touching the front-panel input connectors without first touching the frame of the instrument. Be sure that the instrument is properly earth-grounded to prevent buildup of static charge. Wear a wrist-strap or heel-strap.

Step 12. Perform a Module Calibration***To perform a module calibration***

- 1 On the **Calibrate** menu, choose **All Calibrations**.

The **All Calibrations** dialog box opens. This dialog box allows you to view the calibration status of modules and initiate the calibration.

- 2 Touch the **Modules** tab.

The **Modules** tab opens and allows you to perform a module calibration on either the left or right module.

- 3 Touch the **Calibrate Module** button (located at the bottom of the tab) for the module you need to calibrate. This starts the Module calibration.

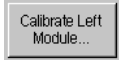

- 4 Remove all external devices and signals from the module.

The module calibration uses known signal levels in the instrument. Introducing an outside signal source will interfere with the calibration factors and decrease the accuracy of the calibration.

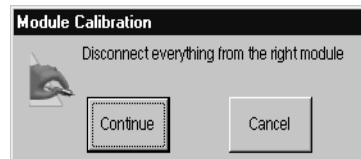

- 5 Touch **Continue**. A progress indicator appears.

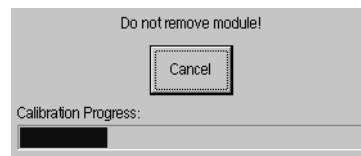

- 6 After the calibration completes, choose **All Calibrations** on the **Calibration** menu.
- 7 The **Module** tab shows the status of the calibration. The tab will look similar to the following figure. Notice that the tab indicates that the “Current user

Step 12. Perform a Module Calibration

module calibration is valid.”

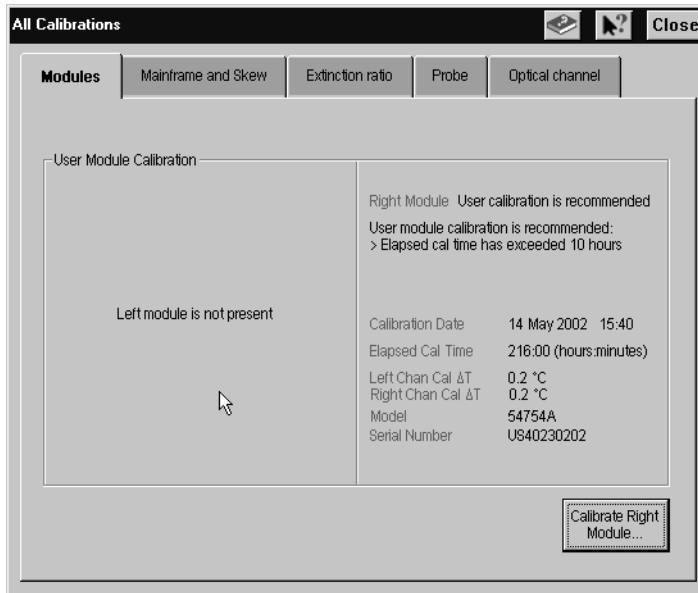

Step 13. For More Information

There are several ways to learn more about your Infiniium DCA.

- Continue reading this book. Chapter 3, “Using the Infiniium DCA” will help you get started using this instrument.
- Refer to the Help. The Help contains the information that would normally be in the user’s guide.
- Visit our website at **<http://www.agilent.com>**. Use the keywords “Infiniium DCA” or “86100B” in your search

Cleaning Connections for Accurate Measurements

Today, advances in measurement capabilities make connectors and connection techniques more important than ever. Damage to the connectors on calibration and verification devices, test ports, cables, and other devices can degrade measurement accuracy and damage instruments. Replacing a damaged connector can cost thousands of dollars, not to mention lost time! This expense can be avoided by observing the simple precautions presented in this book. This book also contains a brief list of tips for caring for electrical connectors.

Choosing the Right Connector

A critical but often overlooked factor in making a good lightwave measurement is the selection of the fiber-optic connector. The differences in connector types are mainly in the mechanical assembly that holds the ferrule in position against another identical ferrule. Connectors also vary in the polish, curve, and concentricity of the core within the cladding. Mating one style of cable to another requires an adapter. Agilent Technologies offers adapters for most instruments to allow testing with many different cables. [Figure 1-1 on page 1-31](#) shows the basic components of a typical connectors.

The system tolerance for reflection and insertion loss must be known when selecting a connector from the wide variety of currently available connectors. Some items to consider when selecting a connector are:

- How much insertion loss can be allowed?
- Will the connector need to make multiple connections? Some connectors are better than others, and some are very poor for making repeated connections.
- What is the reflection tolerance? Can the system take reflection degradation?
- Is an instrument-grade connector with a precision core alignment required?
- Is repeatability tolerance for reflection and loss important? Do your specifica-

tions take repeatability uncertainty into account?

- Will a connector degrade the return loss too much, or will a fusion splice be required? For example, many DFB lasers cannot operate with reflections from connectors. Often as much as 90 dB isolation is needed.

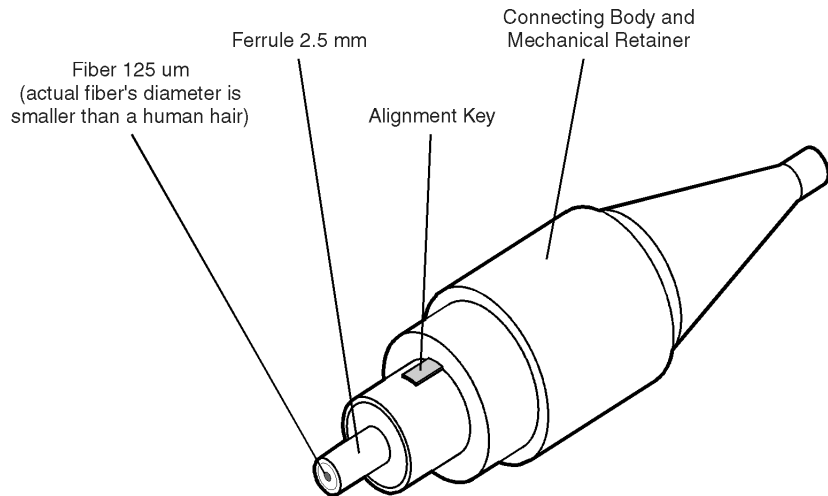

Figure 1-1. Basic components of a connector.

Over the last few years, the FC/PC style connector has emerged as the most popular connector for fiber-optic applications. While not the highest performing connector, it represents a good compromise between performance, reliability, and cost. If properly maintained and cleaned, this connector can withstand many repeated connections.

However, many instrument specifications require tighter tolerances than most connectors, including the FC/PC style, can deliver. These instruments cannot tolerate connectors with the large non-concentricities of the fiber common with ceramic style ferrules. When tighter alignment is required, Agilent Technologies instruments typically use a connector such as the Diamond HMS-10, which has concentric tolerances within a few tenths of a micron. Agilent Technologies then uses a special universal adapter, which allows other cable types to mate with this precision connector. See [Figure 1-2](#).

Setting Up the Infiniium DCA
Choosing the Right Connector



Figure 1-2. Universal adapters to Diamond HMS-10.

The HMS-10 encases the fiber within a soft nickel silver (Cu/Ni/Zn) center which is surrounded by a tough tungsten carbide casing, as shown in [Figure 1-3](#).

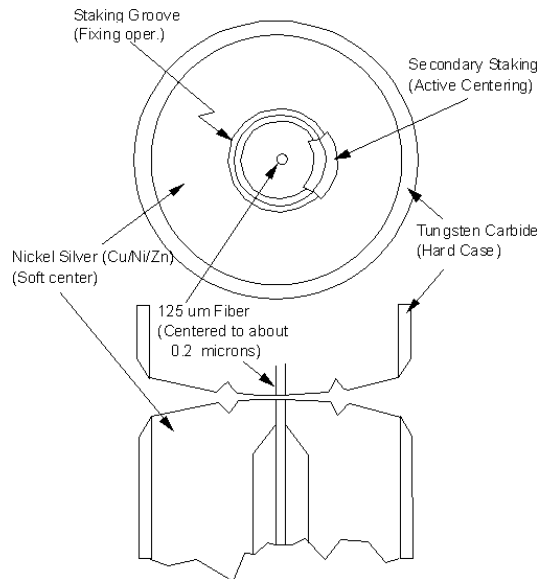

Figure 1-3. Cross-section of the Diamond HMS-10 connector.

The nickel silver allows an active centering process that permits the glass fiber to be moved to the desired position. This process first stakes the soft nickel silver to fix the fiber in a near-center location, then uses a post-active staking to shift the fiber into the desired position within 0.2 μm. This process, plus the keyed axis, allows very precise core-to-core alignments. This connector is found on most Agilent Technologies lightwave instruments.

The soft core, while allowing precise centering, is also the chief liability of the connector. The soft material is easily damaged. Care must be taken to minimize excessive scratching and wear. While minor wear is not a problem if the

glass face is not affected, scratches or grit can cause the glass fiber to move out of alignment. Also, if unkeyed connectors are used, the nickel silver can be pushed onto the glass surface. Scratches, fiber movement, or glass contamination will cause loss of signal and increased reflections, resulting in poor return loss.

Inspecting Connectors

Because fiber-optic connectors are susceptible to damage that is not immediately obvious to the naked eye, bad measurements can be made without the user even being aware of a connector problem. Although microscopic examination and return loss measurements are the best way to ensure good connections, they are not always practical. An awareness of potential problems, along with good cleaning practices, can ensure that optimum connector performance is maintained. With glass-to-glass interfaces, it is clear that any degradation of a ferrule or the end of the fiber, any stray particles, or finger oil can have a significant effect on connector performance.

[Figure 1-4](#) shows the end of a clean fiber-optic cable. The dark circle in the center of the micrograph is the fiber's 125 μm core and cladding which carries the light. The surrounding area is the soft nickel-silver ferrule. [Figure 1-5](#) shows a dirty fiber end from neglect or perhaps improper cleaning. Material is smeared and ground into the end of the fiber causing light scattering and poor reflection. Not only is the precision polish lost, but this action can grind off the glass face and destroy the connector.

[Figure 1-6](#) shows physical damage to the glass fiber end caused by either repeated connections made without removing loose particles or using improper cleaning tools. When severe, the damage on one connector end can be transferred to another good connector that comes in contact with it.

The cure for these problems is disciplined connector care as described in the following list and in [“Cleaning Connectors” on page 1-36](#).

Use the following guidelines to achieve the best possible performance when making measurements on a fiber-optic system:

- Never use metal or sharp objects to clean a connector and never scrape the connector.
- Avoid matching gel and oils.

Inspecting Connectors

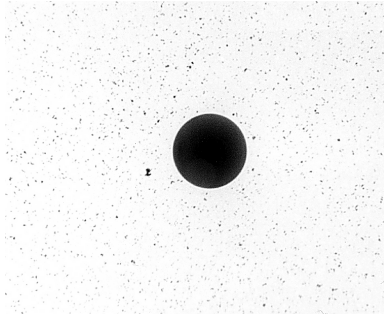

Figure 1-4. Clean, problem-free fiber end and ferrule.

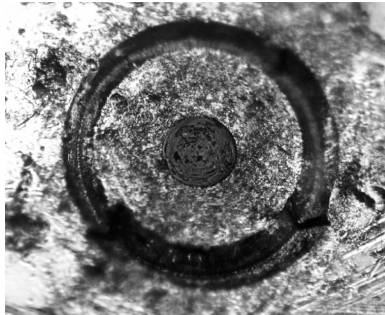

Figure 1-5. Dirty fiber end and ferrule from poor cleaning.



Figure 1-6. Damage from improper cleaning.

While these often work well on first insertion, they are great dirt magnets. The oil or gel grabs and holds grit that is then ground into the end of the fiber. Also, some early gels were designed for use with the FC, non-contacting con-

nectors, using small glass spheres. When used with contacting connectors, these glass balls can scratch and pit the fiber. If an index matching gel or oil must be used, apply it to a freshly cleaned connector, make the measurement, and then immediately clean it off. Never use a gel for longer-term connections and never use it to improve a damaged connector. The gel can mask the extent of damage and continued use of a damaged fiber can transfer damage to the instrument.

- When inserting a fiber-optic cable into a connector, gently insert it in as straight a line as possible. Tipping and inserting at an angle can scrape material off the inside of the connector or even break the inside sleeve of connectors made with ceramic material.
- When inserting a fiber-optic connector into a connector, make sure that the fiber end does not touch the outside of the mating connector or adapter.
- Avoid over tightening connections.

Unlike common electrical connections, tighter is *not* better. The purpose of the connector is to bring two fiber ends together. Once they touch, tightening only causes a greater force to be applied to the delicate fibers. With connectors that have a convex fiber end, the end can be pushed off-axis resulting in misalignment and excessive return loss. Many measurements are actually improved by backing off the connector pressure. Also, if a piece of grit does happen to get by the cleaning procedure, the tighter connection is more likely to damage the glass. Tighten the connectors just until the two fibers touch.

- Keep connectors covered when not in use.
- Use fusion splices on the more permanent critical nodes. Choose the best connector possible. Replace connecting cables regularly. Frequently measure the return loss of the connector to check for degradation, and clean every connector, every time.

All connectors should be treated like the high-quality lens of a good camera. The weak link in instrument and system reliability is often the inappropriate use and care of the connector. Because current connectors are so easy to use, there tends to be reduced vigilance in connector care and cleaning. It takes only one missed cleaning for a piece of grit to permanently damage the glass and ruin the connector.

Measuring insertion loss and return loss

Consistent measurements with your lightwave equipment are a good indication that you have good connections. Since return loss and insertion loss are key factors in determining optical connector performance they can be used to determine connector degradation. A smooth, polished fiber end should pro-

Cleaning Connectors

duce a good return-loss measurement. The quality of the polish establishes the difference between the “PC” (physical contact) and the “Super PC” connectors. Most connectors today are physical contact which make glass-to-glass connections, therefore it is critical that the area around the glass core be clean and free of scratches. Although the major area of a connector, excluding the glass, may show scratches and wear, if the glass has maintained its polished smoothness, the connector can still provide a good low level return loss connection.

If you test your cables and accessories for insertion loss and return loss upon receipt, and retain the measured data for comparison, you will be able to tell in the future if any degradation has occurred. Typical values are less than 0.5 dB of loss, and sometimes as little as 0.1 dB of loss with high performance connectors. Return loss is a measure of reflection: the less reflection the better (the larger the return loss, the smaller the reflection). The best physically contacting connectors have return losses better than 50 dB, although 30 to 40 dB is more common.

Visual inspection of fiber ends

Visual inspection of fiber ends can be helpful. Contamination or imperfections on the cable end face can be detected as well as cracks or chips in the fiber itself. Use a microscope (100X to 200X magnification) to inspect the entire end face for contamination, raised metal, or dents in the metal as well as any other imperfections. Inspect the fiber for cracks and chips. Visible imperfections not touching the fiber core may not affect performance (unless the imperfections keep the fibers from contacting).

Cleaning Connectors

The procedures in this section provide the proper steps for cleaning fiber-optic cables and Agilent Technologies universal adapters. The initial cleaning, using the alcohol as a solvent, gently removes any grit and oil. If a caked-on layer of material is still present, (this can happen if the beryllium-copper sides of the ferrule retainer get scraped and deposited on the end of the fiber during insertion of the cable), a second cleaning should be performed. It is not uncommon for a cable or connector to require more than one cleaning.

CAUTION

Agilent Technologies strongly recommends that index matching compounds *not* be applied to their instruments and accessories. Some compounds, such as gels, may be difficult to remove and can contain damaging particulates. If you think the use of such compounds is necessary, refer to the compound manufacturer for information on application and cleaning procedures.

Table 1-10. Cleaning Accessories

Item	Agilent Part Number
Isopropyl alcohol	8500-5344
Cotton swabs	8520-0023
Small foam swabs	9300-1223
Compressed dust remover (non-residue)	8500-5262

Table 1-11. Dust Caps Provided with Lightwave Instruments

Item	Agilent Part Number
Laser shutter cap	08145-64521
FC/PC dust cap	08154-44102
Biconic dust cap	08154-44105
DIN dust cap	5040-9364
HMS10/dust cap	5040-9361
ST dust cap	5040-9366

To clean a non-lensed connector

CAUTION

Do not use any type of foam swab to clean optical fiber ends. Foam swabs can leave filmy deposits on fiber ends that can degrade performance.

- 1** Apply pure isopropyl alcohol to a clean lint-free cotton swab or lens paper.
Cotton swabs can be used as long as no cotton fibers remain on the fiber end after cleaning.
- 2** Clean the ferrules and other parts of the connector while avoiding the end of the fiber.
- 3** Apply isopropyl alcohol to a new clean lint-free cotton swab or lens paper.
- 4** Clean the fiber end with the swab or lens paper.
Do *not* scrub during this initial cleaning because grit can be caught in the swab and become a gouging element.
- 5** Immediately dry the fiber end with a clean, dry, lint-free cotton swab or lens paper.
- 6** Blow across the connector end face from a distance of 6 to 8 inches using

Cleaning Connectors

filtered, dry, compressed air. Aim the compressed air at a shallow angle to the fiber end face.

Nitrogen gas or compressed dust remover can also be used.

CAUTION

Do not shake, tip, or invert compressed air canisters, because this releases particles in the can into the air. Refer to instructions provided on the compressed air canister.

- 7 As soon as the connector is dry, connect or cover it for later use.

If the performance, after the initial cleaning, seems poor try cleaning the connector again. Often a second cleaning will restore proper performance. The second cleaning should be more arduous with a scrubbing action.

To clean an adapter

The fiber-optic input and output connectors on many Agilent Technologies instruments employ a universal adapter such as those shown in the following picture. These adapters allow you to connect the instrument to different types of fiber-optic cables.



Figure 1-7. Universal adapters.

- 1 Apply isopropyl alcohol to a clean foam swab.

Cotton swabs can be used as long as no cotton fibers remain after cleaning. The foam swabs listed in this section's introduction are small enough to fit into adapters.

Although foam swabs can leave filmy deposits, these deposits are very thin, and the risk of other contamination buildup on the inside of adapters greatly outweighs the risk of contamination by foam swabs.

- 2 Clean the adapter with the foam swab.
- 3 Dry the inside of the adapter with a clean, dry, foam swab.
- 4 Blow through the adapter using filtered, dry, compressed air.

Nitrogen gas or compressed dust remover can also be used. Do not shake, tip, or invert compressed air canisters, because this releases particles in the can into the air. Refer to instructions provided on the compressed air canister.

Returning the Instrument for Service

The instructions in this section show you how to properly package the instrument for return to a Agilent Technologies service office. For a list of offices, refer to [“Agilent Technologies Service Offices” on page 1-43](#).

If the instrument is still under warranty or is covered by an Agilent maintenance contract, it will be repaired under the terms of the warranty or contract (the warranty is at the front of this manual). If the instrument is no longer under warranty or is not covered by an Agilent maintenance plan, Agilent will notify you of the cost of the repair after examining the unit.

When an instrument is returned to a Agilent service office for servicing, it must be adequately packaged and have a complete description of the failure symptoms attached.

When describing the failure, please be as specific as possible about the nature of the problem. Include copies of additional failure information (such as the instrument failure settings, data related to instrument failure, and error messages) along with the original cal data disks and the instrument being returned.

Please notify the service office before returning your instrument for service. Any special arrangements for the instrument can be discussed at this time. This will help the Agilent service office repair and return your instrument as quickly as possible.

Preparing the instrument for shipping

- 1 Write a complete description of the failure and attach it to the instrument. Include any specific performance details related to the problem. The following

Preparing the instrument for shipping

information should be returned with the instrument.

- Type of service required.
 - Date instrument was returned for repair.
 - Description of the problem:
 - Whether problem is constant or intermittent.
 - Whether instrument is temperature-sensitive.
 - Whether instrument is vibration-sensitive.
 - Instrument settings required to reproduce the problem.
 - Performance data.
 - Company name and return address.
 - Name and phone number of technical contact person.
 - Model number of returned instrument.
 - Full serial number of returned instrument.
 - List of any accessories returned with instrument.
 - The original cal data disks.
- 2** Cover all front or rear-panel connectors that were originally covered when you first received the instrument.

CAUTION

Cover electrical connectors to protect sensitive components from electrostatic damage. Cover optical connectors to protect them from damage due to physical contact or dust.

CAUTION

Instrument damage can result from using packaging materials other than the original materials. Never use styrene pellets as packaging material. They do not adequately cushion the instrument or prevent it from shifting in the carton. They may also cause instrument damage by generating static electricity.

- 3** Pack the instrument in the original shipping containers. Original materials are available through any Agilent office. Or, use the following guidelines:
- Wrap the instrument in antistatic plastic to reduce the possibility of damage caused by electrostatic discharge.
 - For instruments weighing less than 54 kg (120 lb), use a double-walled, corrugated cardboard carton of 159 kg (350 lb) test strength.
 - The carton must be large enough to allow approximately 7 cm (3 inches) on all sides of the instrument for packing material, and strong enough to accommodate the weight of the instrument.
 - Surround the equipment with approximately 7 cm (3 inches) of packing material, to protect the instrument and prevent it from moving in the carton. If packing foam is not available, the best alternative is S.D-240 Air Cap™ from

Preparing the instrument for shipping

Sealed Air Corporation (Commerce, California 90001). Air Cap looks like a plastic sheet filled with air bubbles. Use the pink (antistatic) Air Cap™ to reduce static electricity. Wrapping the instrument several times in this material will protect the instrument and prevent it from moving in the carton.

- 4** Seal the carton with strong nylon adhesive tape.
- 5** Mark the carton “FRAGILE, HANDLE WITH CARE”.
- 6** Retain copies of all shipping papers.

Hard Drive Recovery

The Infiniium DCA hard drive recovery system offers a way to recover from situations when the instrument hard drive configuration becomes corrupt due to inadvertent user changes to the instrument or to a virus infection.

The Infiniium DCA hard disk recovery system consists one floppy disk, one CD-ROM, and instructions. The recovery process will re-image the internal disk drive on the Agilent 86100B. After the recovery process is complete, the Infiniium DCA firmware is set to the latest revision as indicated on the recovery disks.

NOTE

Please be advised that all user files and the user network configuration settings will be lost during the recovery process.

To order a free hard drive recovery package, visit

<http://www.agilent.com/comms/dca>

Agilent Technologies Service Offices

Call Center

For technical assistance, you can contact your local Agilent Call Center.

- In the Americas, call 1 (800) 452-4844
- In other regions, visit <http://www.agilent.com> and click **Contact Us**.

Service Center

Before returning an instrument for service, you must first call the Agilent Technologies Instrument Support Center.

- In all regions, call (800) 403-0801

Setting Up the Infiniium DCA

Service Center

Working in Comfort

Working in Comfort

To optimize your comfort and productivity, it is important that you set up your work area correctly and use your Agilent product properly. With that in mind, we have developed some setup and use recommendations for you to follow based on established ergonomic principles.

Improper and prolonged use of keyboards and input devices are among those tasks that have been associated with repetitive strain injury (RSI) to soft tissues in the hands and arms. If you experience discomfort or pain while using your Agilent Technologies product, discontinue use immediately and consult your physician as soon as possible.

Please study the recommendations offered here in this chapter. You may also wish to consult your employer's human resources department or other relevant departments for guidance specific to your company.

About Repetitive Strain Injury

Because your comfort and safety are our primary concern, we strongly recommend that you use the infinity DCA in accordance with established ergonomic principles and recommendations. Scientific literature suggests that there may be a relationship between injury to soft tissues - especially in the hands and arms - and prolonged improper use of keyboards or other equipment requiring repeated motions of the hands and forearms. This literature also suggests that there are many other risk factors that may increase the chance of such injury, commonly called Repetitive Strain Injury.

What is RSI?

Repetitive Strain Injury (RSI—also known as cumulative trauma disorder or repetitive motion injury) is a type of injury where soft tissues in the body, such as muscles, nerves, or tendons, become irritated or inflamed. RSI has been a reported problem for those who perform repetitive tasks such as assembly line work, meatpacking, sewing, playing musical instruments, and computer work.

RSI has also been observed in those who frequently engage in activities such as carpentry, knitting, housework, gardening, tennis, windsurfing and lifting children.

What causes RSI? The specific causes of RSI have not been established. Nevertheless, the incidence of RSI has been associated with a variety of risk factors, including:

- Too many uninterrupted repetitions of an activity or motion.
- Performing an activity in an awkward or unnatural posture.
- Maintaining a static position for prolonged periods.
- Failing to take frequent short breaks.
- Other environmental and social factors.

In addition, there have been reports associating the occurrence of RSI with the use of keyboards, mice, and other input devices. Also, certain medical conditions, such as rheumatoid arthritis, obesity and diabetes, may predispose people to this type of injury.

What if I experience discomfort?

If you are experiencing any discomfort, seek professional medical advice immediately. Typically, the earlier a problem is diagnosed and treated, the easier it is to resolve.

Mice and Other Input Devices

Various aspects of using mice and other input devices may increase your risk of discomfort or injury. Observing the following recommendations may reduce that risk.

- Try to keep your hand, wrist, and forearm in a neutral position while using your mouse or other input device.
- If you use your thumb to rotate the ball on a trackball or spaceball, keep it in a relaxed, natural shape, and maintain a neutral posture in your hand, wrist, and forearm.
- Hold the mouse gently by draping your fingers over it. Keep your hand relaxed and fingers loose. Do not grip the mouse tightly.
- It takes very little pressure or force from your fingers to activate the buttons or scroll wheel on your mouse, scrolling mouse, trackball, or other input device. Using too much force can place unnecessary stress on the tendons and muscles

Mice and Other Input Devices

in your hands, wrists, and forearms.

- If you are using a scrolling mouse, be sure to keep your fingers and hand in a relaxed, neutral position when activating the scroll wheel. Also, this type of mouse features software that can minimize the number of mouse movements or button clicks.
- When using a mouse, trackball, or other input device, position it as close to the keyboard as possible, and keep it at the same level as you do not have to stretch while using it.
- Use a good quality mouse pad to enable the mouse to work most effectively and reduce unnecessary hand and wrist movements.
- Be sure to keep your mouse and trackball clean. Regular removal of accumulated dust and dirt helps ensure proper tracking and reduces unnecessary hand and wrist motions.

Introduction	3-2
Oscilloscope Mode	3-8
Eye/Mask Mode	3-7
TDR/TDT Mode	3-9
Using Plug-in Modules	3-10
Using the Touch Screen	3-12
Using the Quick Measure Feature	3-13
If the Display Goes Blank	3-14
Hiding and Moving Dialog Boxes	3-15
Menus	3-16

Using the Infiniium DCA

Introduction

The Infiniium DCA is designed to measure a variety of high speed digital communication waveforms. You can operate it in any of the following three instrument modes:

- Eye/Mask Mode (100 Mb/s to 10 Gb/s) for eye diagram analysis and standards testing (for example, SONET/SDH, Gigabit Ethernet, and Fiber Channel).
- TDR/TDT Mode for time domain reflectometry measurements
- Oscilloscope Mode (DC to 20 GHz or 50 GHz)

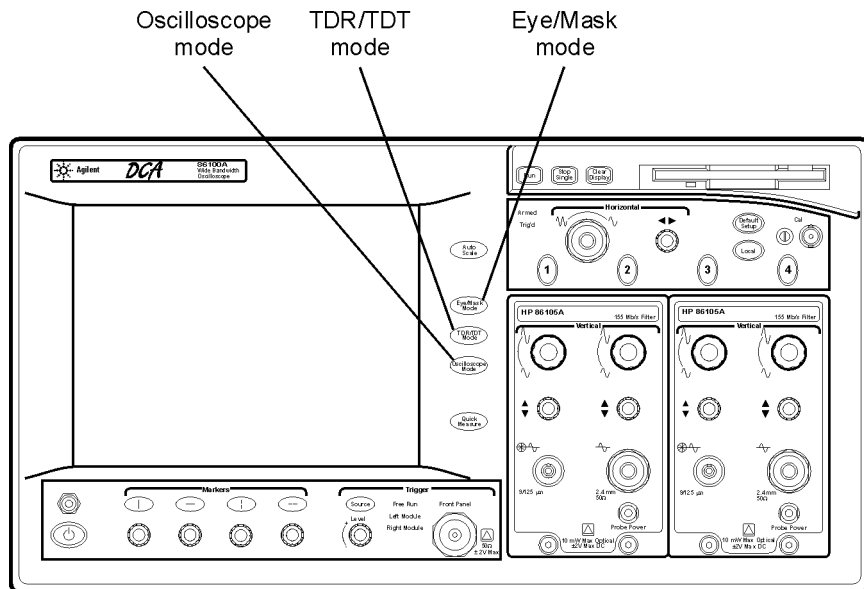

Use the touch screen

You can explore the instrument's menus and change its settings by touching the display. Notice that the measurement toolbar changes depending on the selected instrument mode. Touch the channel, time and delay, and trigger level buttons located at the bottom of the display to change the horizontal and vertical scales. Or, you can change these settings using front-panel knobs and buttons.

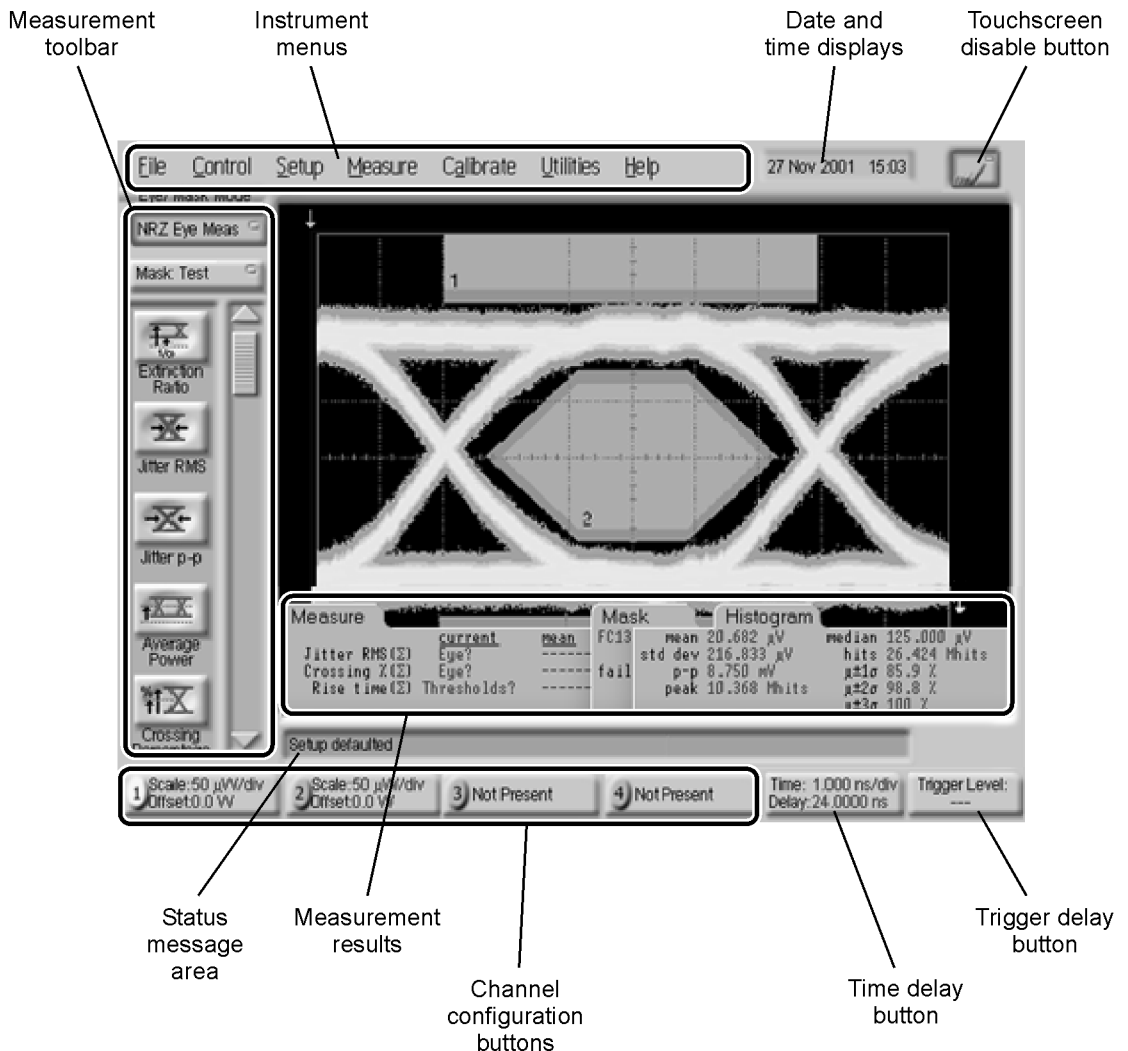

Introduction

Refer to the Help System

To learn how to use your Infiniium DCA and to locate information on specifications (including plug-in modules), instrument features, and measurement configuration refer to [Chapter 4, “Using the Built-In Information System”](#) in this book.

You must provide a trigger input signal

Because high-speed oscilloscopes are not capable of triggering directly on a test signal, you must first connect an external timing reference signal to the front-panel trigger input connector. This input allows the Infiniium DCA to synchronize to the input signal. You can select free-run triggering when an external trigger is unavailable. However, you will only be able to view the waveform for amplitude information only without any timing information. This is an easy way to examine the amplitude of a signal.

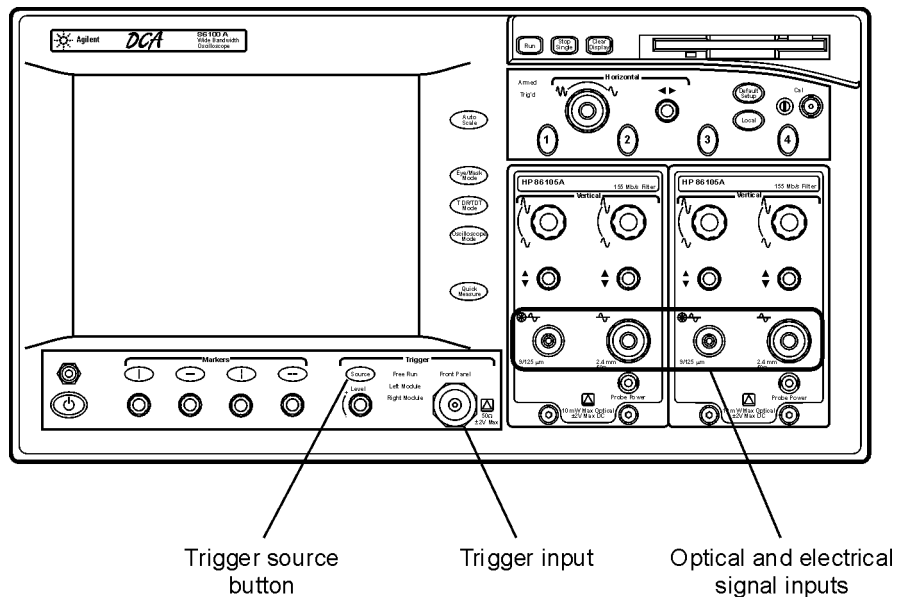

Front-panel features

The following figure shows the input connectors, controls, power switch, and other front-panel features available on the Infiniium DCA.

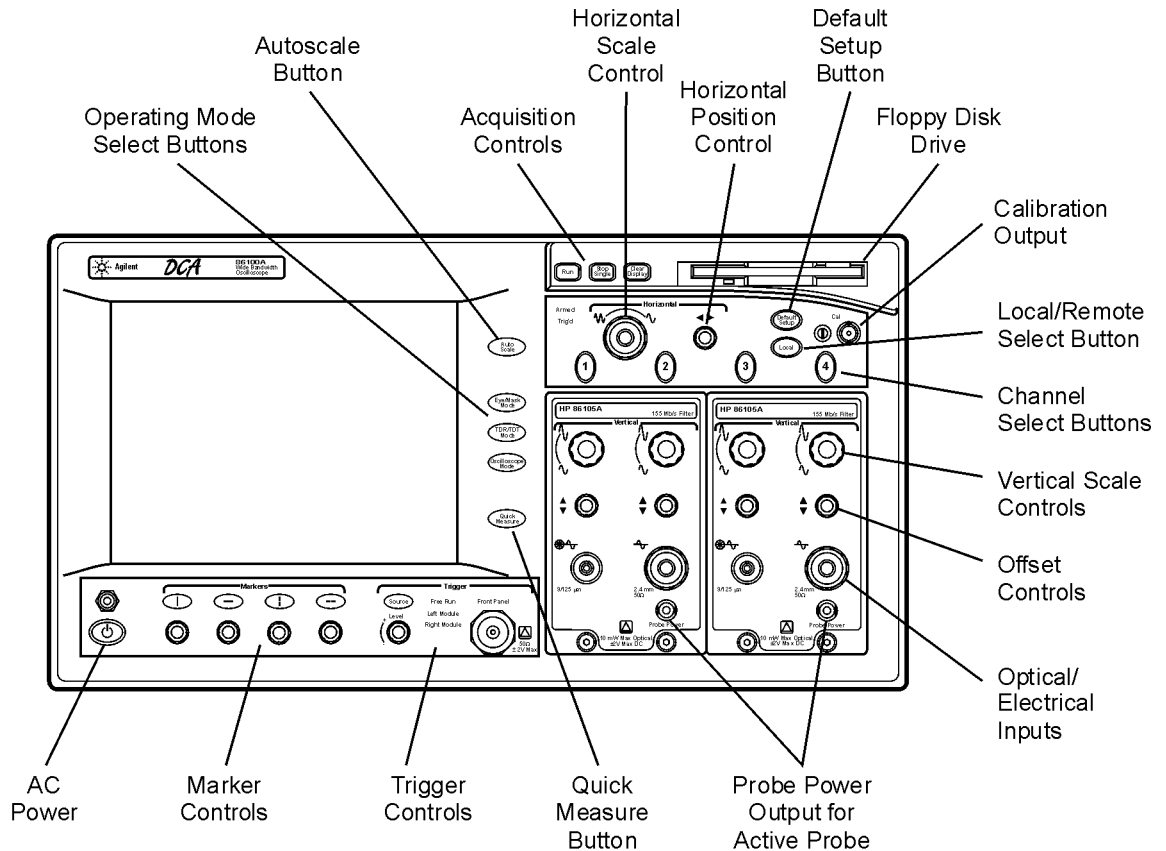

Introduction

Rear-panel features

The following figure shows the rear-panel input connections available on the Infiniium DCA.

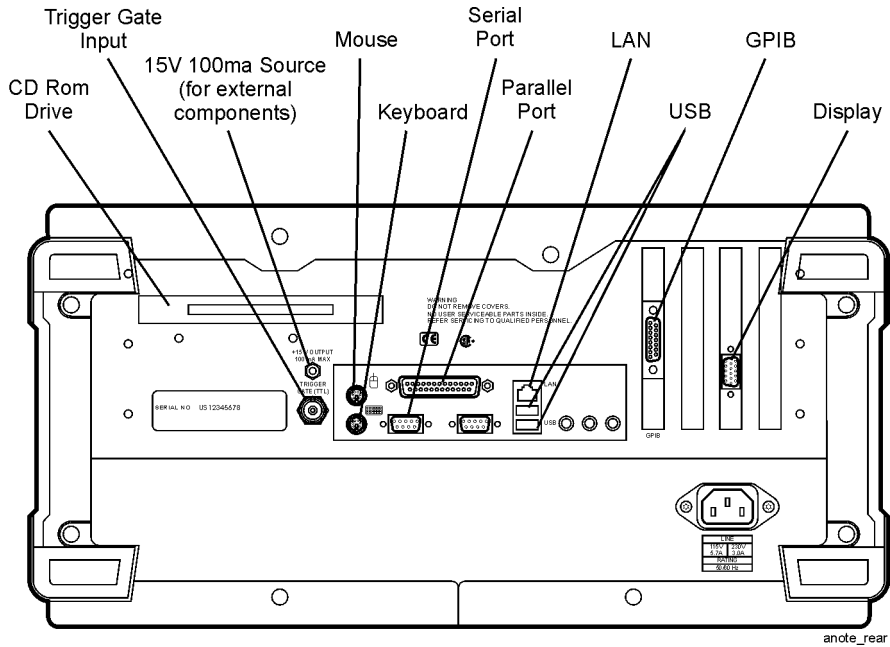

Eye/Mask Mode

The Eye/Mask mode allows you to perform NRZ (Non-Return to Zero), or RZ (Return to Zero) eye diagram measurements and eye mask tests. The eye diagram is typically produced by triggering the instrument with a synchronous clock signal.

Eye/Mask mode measurements only work when an eye diagram, and not a pulse, is present on the screen. Measurements made on a pulse waveform while in Eye/Mask mode will fail.

Once you are in Eye/Mask mode, press the Autoscale button. This ensures that an optimum eye diagram is displayed on the graticule. An optimum eye diagram consists of a full display of the eye in addition to portions of the waveform preceding and following the eye.

When you select the Eye/Mask mode, the measurement toolbars shown here appear. These measurement toolbars include measurements such as rise time, fall time, jitter, and extinction ratio, as well as the mask test start and stop controls.

Eye measurement and mask test results appear below the display graticule. A maximum of four eye measurement test results are displayed and include any failures or instrument messages that may occur.

To learn more about the Eye/Mask mode and switching from NRZ to RZ measurement mode, consult the Help.

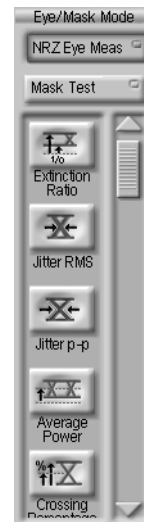
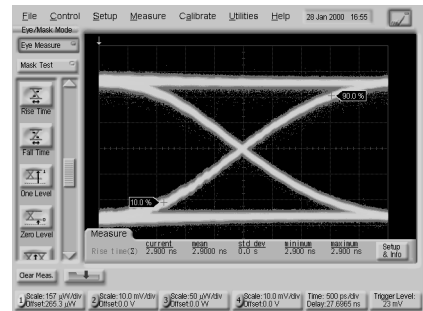

Oscilloscope Mode

Use the Oscilloscope mode for pulse type waveforms that are triggered by an external signal. Oscilloscope mode measurements only work when a single valued waveform, and not an eye diagram, is present on the screen.

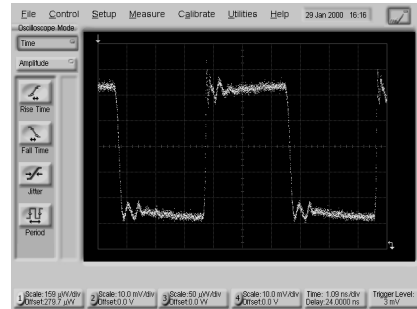

When you select the Oscilloscope mode, the measurement toolbars shown here appear. These measurement toolbars include measurements such as rise time, fall time, overshoot, and Vp-p. All measurements, with the exception of jitter, can be performed on any of the following sources: channels, waveform memories, and math functions. One of the above sources must be turned on in order to perform an oscilloscope measurement.

If more than one source is turned on and you initiate a measurement, the Enter Measurement Info dialog box opens. This dialog box allows you to select the source you want to use for the measurement.

Measurement results appear below the display graticule. A maximum of four pulse measurement test results are displayed and include any failures or instrument messages that may occur.

To learn more about the Oscilloscope mode, consult the Help.



TDR/TDT Mode

The TDR/TDT mode allows you use time domain reflectometry (TDR) to verify the proper functioning of the physical components of your device under test using a time-delayed electrical pulse. You can also use time domain transmission (TDT) to measure both the attenuation and propagation delay of your device under test.

TDR/TDT mode measurements when using a single-ended or differential TDR/TDT 5475x series plug-in module.

When you select the TDR/TDT mode, the measurement toolbar shown here appears. This measurement toolbar includes measurements such as Quick TDR, normalization, rise time, and fall time. Quick TDR allows you to view an immediate display of the characteristics of your device under test. You can also use this toolbar to perform tasks such as setting up the stimulus and destination for your measurement.

You can use markers to to verify the impedance, voltage, and percent of reflection of a selected point on the waveform trace. TDR/TDT markers are initiated by turning on the X-axis marker(s) only. The Y-axis marker(s) will then track the waveform at the position determined by the X-axis marker. You can view the position of the marker values in the marker values tab located below the display graticule.

To learn more about the TDR/TDT mode, consult the Help.

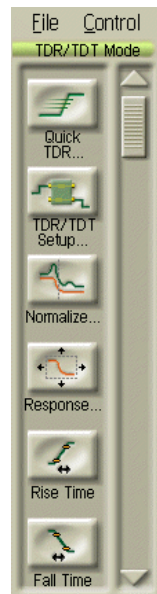
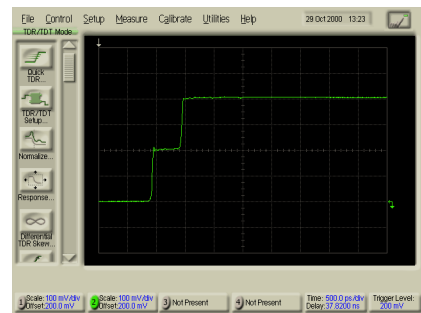

Using Plug-in Modules

The Infiniium DCA holds up to two plug-in modules, which can provide up to four measurement channels. Each input channel has its own vertical controls. The amplitude scale knob adjusts the amplitude scale used for the input channel. Use the amplitude offset knob to position the displayed signal. You can also set the amplitude scale and offset to specific values by touching of channel buttons shown to at the bottom of the display.

To install a module

- Slide the module into an available slot and finger tighten the two front-panel locking screws.

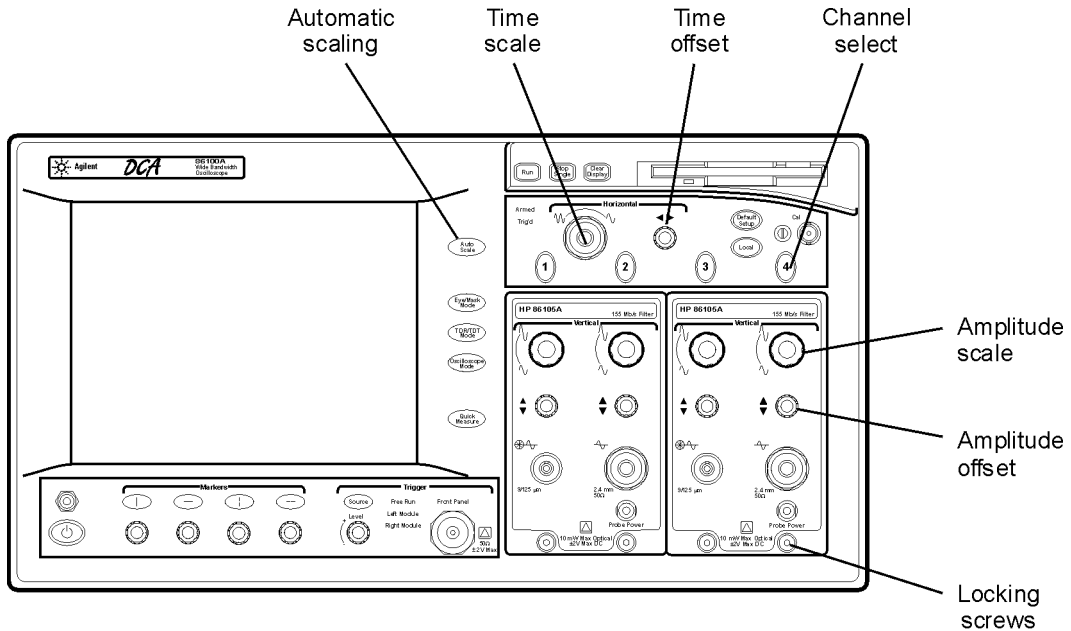

You can use 8348x and 5475x series plug-in modules

In addition to a complete line of modules designed specifically for this instrument, modules designed for use with HP/Agilent 83480A and 54750A mainframes can also be installed into the Infiniium DCA. The 8348x and 5475x series plug-in modules are equipped with a trigger input on the individual module front panels. Repeatedly press the Infiniium DCA's front-panel Trigger Source button until the label for the desired trigger source is lit.

CAUTION

Electrical channel input circuits and the trigger input circuit can be damaged by electrostatic discharge (ESD). Avoid applying static discharges to the front-panel input connectors. Prior to connecting any coaxial cable to the connectors, momentarily short the center and outer conductors of the cable together. Avoid touching the front-panel input connectors without first touching the frame of the instrument. Be sure that the instrument is properly earth-grounded to prevent buildup of static charge. Wear a wrist-strap or heel-strap.

CAUTION

Optical channel fiber-optic connectors are easily damaged when connected to dirty or damaged cables and accessories. When you use improper cleaning and handling techniques, you risk expensive instrument repairs, damaged cables, and compromised measurements. Before you connect any fiber-optic cable to the digital communications analyzer, [refer to “Cleaning Connections for Accurate Measurements” on page 1-30.](#)

Using the Touch Screen

There may be times when you would like to disable the touch screen feature. For example, when pointing out a measurement result without initiating a change to the instrument. You can temporarily disable the touch screen for this purpose.

A touch screen configuration utility can be used to ensure that the touch screen is both aligned and orientated with the display. It also allows you to adjust the touch screen speed to simulate a double-click and to turn the touch screen sound on or off.

To temporarily disable the touch screen

- Touch the disable button which is located at the top of the display. Touch the button a second time to reenale the touch screen.



Using the Quick Measure Feature

Press **Quick Measure** and the Infiniium DCA automatically performs four measurements on a displayed signal. You can configure Quick Measure to include any four measurements located on the measurement tool bar. Quick Measure has a default set of measurements for each instrument mode. For example, in Oscilloscope mode the default measurements are: rise time, fall time, period, and V amplitude. In Eye/Mask mode you can also configure Quick Measure to perform a mask test.

To configure Quick Measure

- On the Measure menu, choose Quick Measure Config.

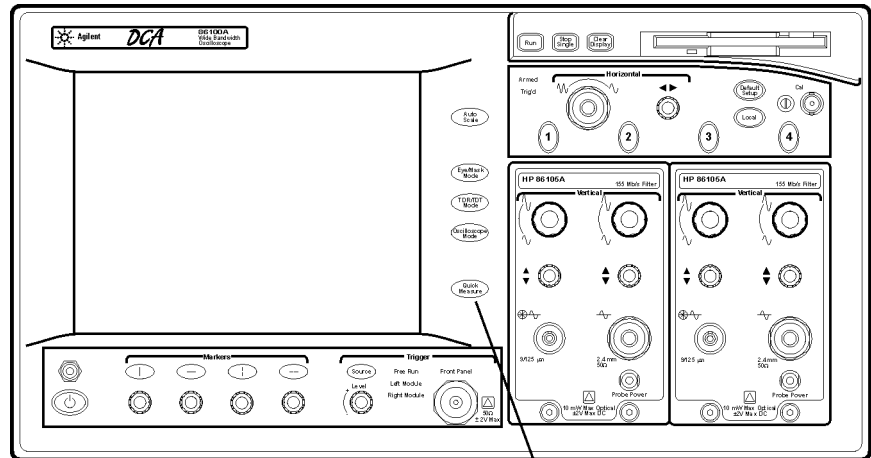

Quick Measure

If the Display Goes Blank

The display automatically turns off if the Infiniium DCA is powered over an eight hour period without being used. The purpose of this feature is to extend the life of the display. You can adjust the amount of time that must elapse before the screen is turned off by the backlight saver utility (for example, 2, 4, 6, or 8 hours). This feature is especially useful if you are using remote measurements or leaving the instrument unattended for long periods of time. Although not recommended, you can disable this control so that the backlight is never turned off during inactivity.

To reactivate the display

- Touch the display screen
- Move the mouse (if applicable)
- Touch any button on the instrument front panel
- Turn any knob on the instrument front panel

To configure the backlight saver

- 1 On the **Setup** menu, choose **Display**.
- 2 Touch **Enabled** to enable or disable the backlight control.

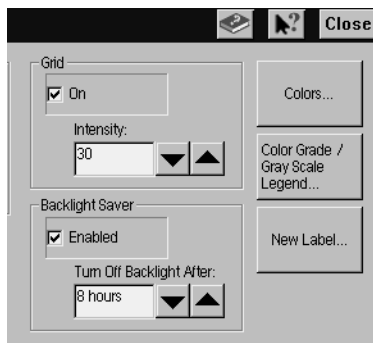

Hiding and Moving Dialog Boxes

Sometimes, dialog boxes may cover portions of a displayed signal and graticule that you wish to see. You can either move the dialog box or make it transparent.

To move a dialog box

- Touch the top of the dialog box, and drag your finger across of display to move the dialog box to a more convenient location.

To make a dialog box transparent

- 1 Select **Dialog Boxes** from the **Setup** menu.
- 2 Touch **Opaque** or **Transparent**.

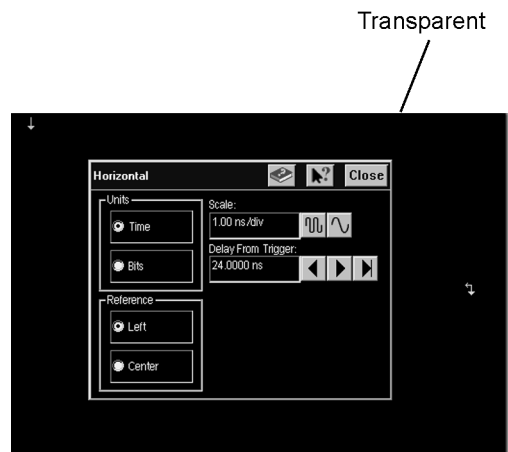
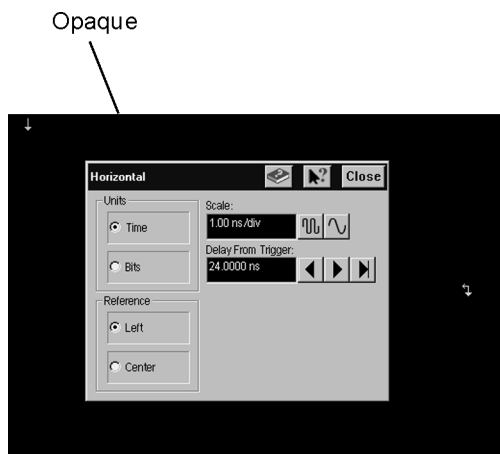

Menus

Menus

The instrument menus provide access to all functions. This section shows the layout of each menu. For detailed information on each of these menus, refer to the Help.

The File menu

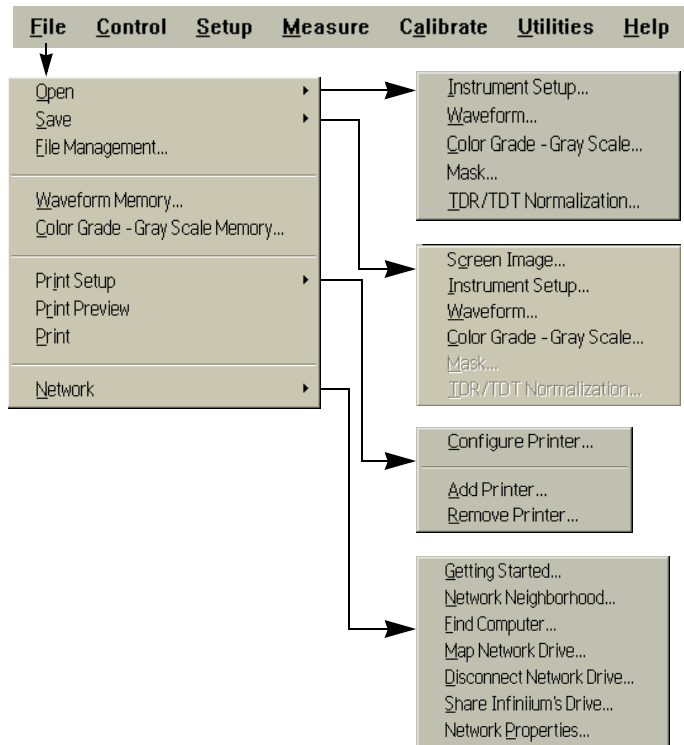

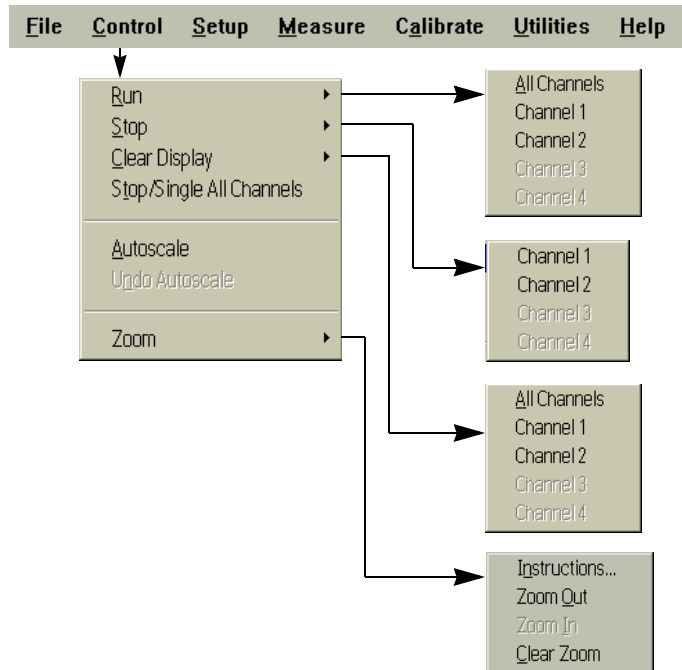
The Control menu

Menus

The Setup menu

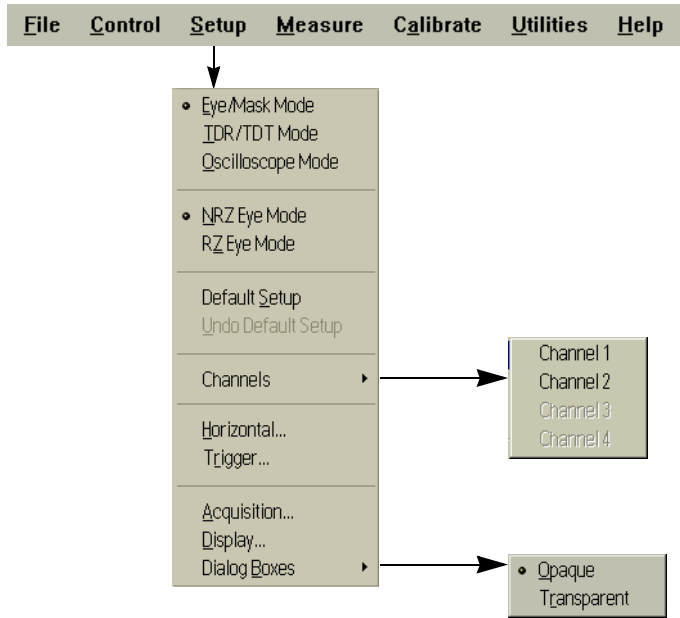

The Measure menu

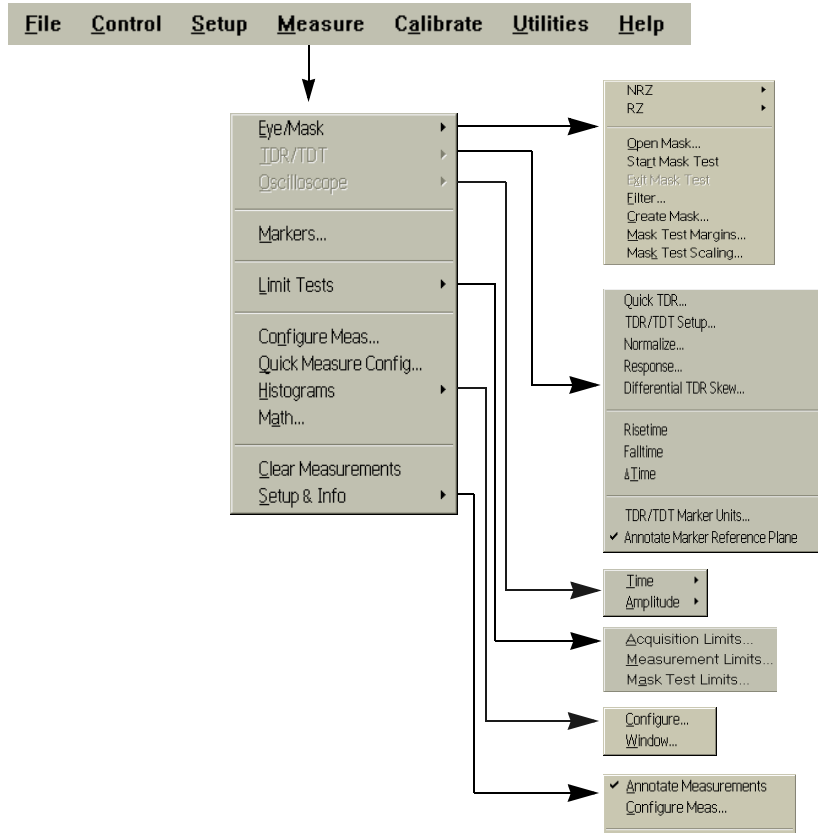

The Calibrate menu

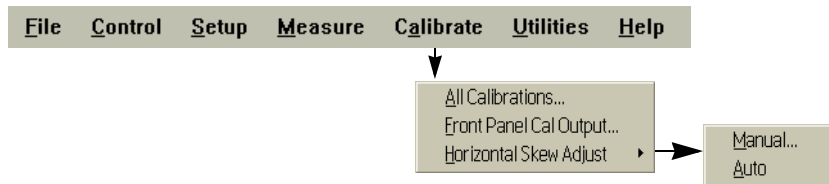

Menus

The Utilities menu

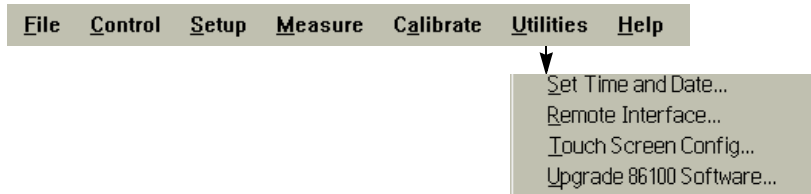

The Help menu

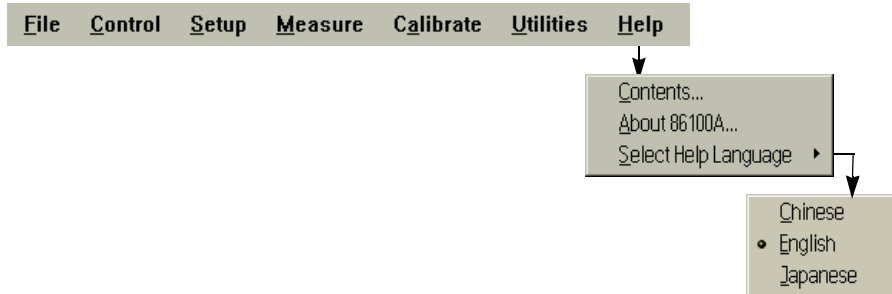

The Infinium DCA Help Contents	4-3
Description of the Contents Topics	4-4
Getting Help While Changing Instrument Settings	4-6
Learning About Measurements Results	4-7
Hiding the Help	4-8
Printing the Contents of a Topic	4-9
Selecting the Help Language	4-10

Using the Built-In Information System

Using the Built-In Information System

Where is the operating manual for your infinium DCA? It is built into your instrument! To access the built-in information system, referred to as Help, simply touch **Contents** on the **Help** menu. This will open the contents topic that is shown in the figure on the following page. In this chapter, you'll learn features that are unique to the Infinium DCA's Help system as well as tips that will make the system more useful to you.

Exploring the Help should be familiar to you because it is similar to other Windows applications. You can, of course, use the touch screen or the mouse to explore the Help.

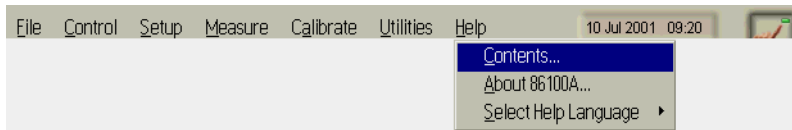

The Infiniium DCA Help Contents

The following figure shows the 86100B Help contents. This is the starting point for learning how to use your Infiniium DCA.

In addition to the 11 topics presented in the contents, be sure to use the index buttons located along the bottom of the topic window. These can be very helpful in locating a topic of interest.

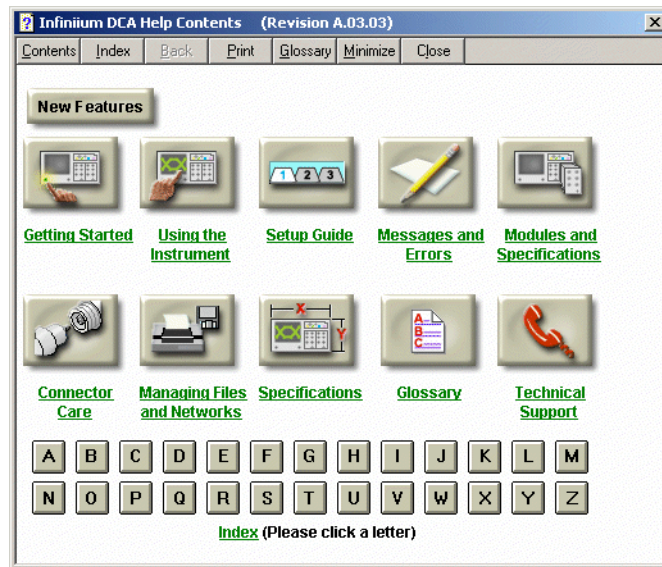

Description of the Contents Topics

The following list describes the information you can find in each of the contents topics.



Getting Started

This topic contains links to useful information you may want to read first.



Using the Instrument

This topic contains links to utilizing the instrument functionality.



Setup Guide

This topic provides step-by-step procedures for many configuration and measurement tasks.



Messages and Errors

This topic contains information about the status of the instrument or an action that has been performed.



Modules and Specifications

This topic contains descriptions and specifications of plug-in modules used with the Infiniium DCA.



Connector Care

This topic provides information about optical and electrical connector care.



Managing Files and Networks

This topic provides information about file management, using your network, and printing.



Instrument Specifications

This topic contains descriptions of all instrument main-frame specifications.



Glossary

This topic provides a list of terms and their definitions.



Technical Support

This topic provides technical support information.

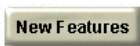

New Features

This topic contains the links to both new and enhanced features in this version of the Infiniium DCA software.

Getting Help While Changing Instrument Settings

Help is available directly from dialog boxes in the graphical user interface.

- To see overview information in an open dialog box, touch the **Book** icon. A topic window opens and describes the dialog box and its controls.
- To get information on a specific item in the dialog box, touch the **What's this?** icon. Then touch the desired control on the dialog box. A window appears with a description of the selected control, as shown in the following figure.

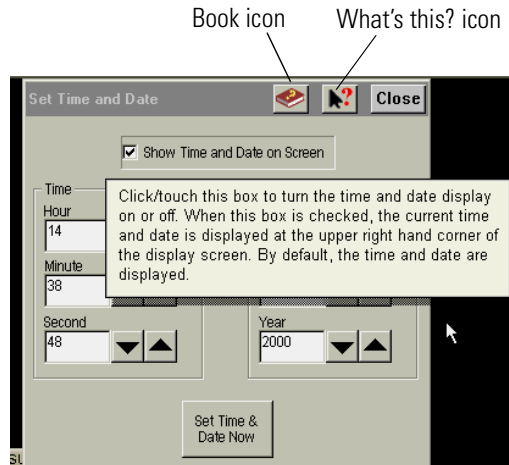

Learning About Measurements Results

After a measurement is performed, the displays shows the Measure tab which includes the measurement results. The fastest way to get help on measurement configuration or algorithms is to touch the **Setup & Info** button. The following figure shows the location of this button.

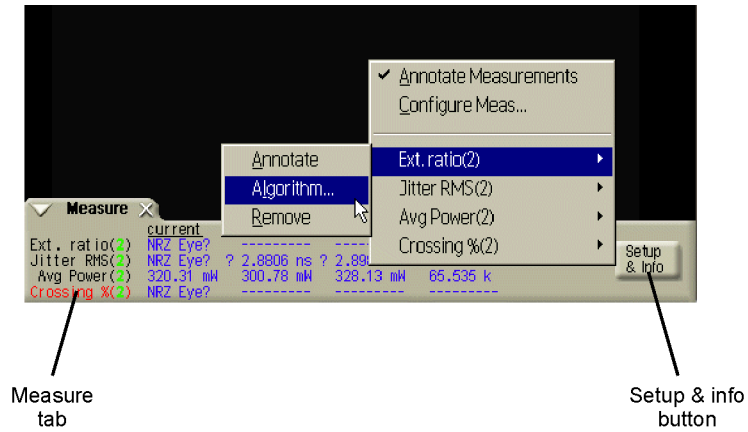

Hiding the Help

When using the Help, you can temporarily hide it so that you can see the entire display. Then, you can re-display the Help with the same topic still showing.

- To hide the Help, touch the **Minimize** button located at the top of the Help window.



- To re-display the Help, touch the **Restore** button that is shown on the display.



Printing the Contents of a Topic

You can print the entire contents of a Help topic or a pop-up window. To print the entire contents of a Help topic, simply touch the **Print** button located at the top of the Help window.

To print the entire contents of a pop-up Help window, by following the steps below.

- 1 Connect a printer and a mouse pointing device to the Infiniium DCA.
- 2 Place the pointer over the topic, and click the right mouse button. Then click **Print Topic**.

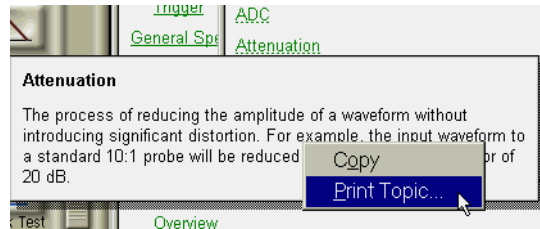

Selecting the Help Language

Help is available in more than one language. On the **Help** menu, touch **Select Help Language**, and then touch the language you want to view. Please ensure that the Help file is closed before changing the language selection. You can only view one version of help at a time.

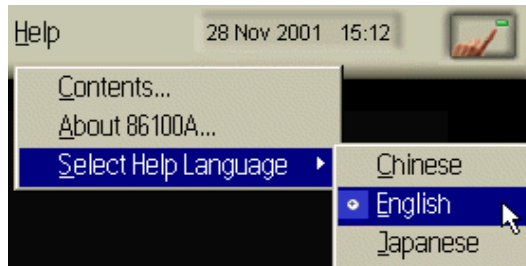

Help Version

Refer to the English version of help to view the most current information about instrument features and specifications.

Regulatory Information

Compliance with German Noise Requirements

This is to declare that this instrument is in conformance with the German Regulation on Noise Declaration for Machines (Laermangabe nach der Maschinenlaermverordnung -3.GSGV Deutschland).

Notice for Germany: Noise Declaration

Acoustic Noise Emission	Geraeuschemission
LpA < 70 dB	LpA < 70 dB
Operator position	am Arbeitsplatz
Normal position	normaler Betrieb
per ISO 7779	nach DIN 45635 t.19

Compliance with Canadian EMC Requirements

This ISM device complies with Canadian ICES-001.

Cet appareil ISM est conforme a la norme NMB du Canada.

Declaration of Conformity - Mainframe



Agilent

DECLARATION OF CONFORMITY

According to ISO/IEC Guide 22 and CEN/CENELEC EN 45014

Manufacturer's Name: Agilent Technologies, Inc.
Manufacturer's Address: 1900 Garden of the Gods Road
Colorado Springs, Colorado
80907 U.S.A.

Declares, that the product

Product Name: Digitizing Oscilloscope
Model Number: 86100B
Product Options: This declaration covers all options of the above product(s).

Conforms with the following product standards:

EMC	Standard	Limit
	IEC 61326-1:1997+A1:1998 / EN 61326-1:1997+A1:1998 CISPR 11:1990 / EN 55011:1991 IEC 61000-4-2:1995+A1:1998 / EN 61000-4-2:1995 IEC 61000-4-3:1995 / EN 61000-4-3:1995 IEC 61000-4-4:1995 / EN 61000-4-4:1995 IEC 61000-4-6:1996 / EN 61000-4-6:1996 Canada: ICES-001:1998 Australia/New Zealand: AS/NZS 2064.1	Group 1 Class A ^[1] 4kV CD, 8kV AD 3V/m, 80-1000 MHz 0.5kV signal lines, 1kV power lines 3V, 0.15-80 MHz
Safety	IEC 61010-1:1990+A1:1992+A2:1995 / EN 61010-1:1993+A2:1995 Canada: CSA C22.2 No. 1010.1:1992	

Conformity / Supplemental Information:

The product herewith complies with the requirements of the Low Voltage Directive 73/23/EEC and the EMC Directive 89/336/EEC (including 93/68/EEC) and carries the CE Marking accordingly (European Union).

^[1] The product was tested in a typical configuration with Agilent Technologies test systems.

Date: 10/18/2001

Name

Ken Wyatt / Product Regulations Manager

For further information, please contact your local Agilent Technologies sales office, agent or distributor.

Declaration of Conformity - Plug-in Modules

Declaration of Conformity - Plug-in Modules

DECLARATION OF CONFORMITY	
According to ISO/IEC Guide 22 and CEN/CENELEC EN 45014	
Manufacturer's Name:	Agilent Technologies, Inc.
Manufacturer's Address:	1400 Fountaingrove Parkway Santa Rosa, CA 95403-1799 USA
Declares that the products:	
Product Name:	Infiniium DCA Agilent 86100-series plug-in modules
Model Number:	86101A, 86102A, 86102U, 86103A, 86103B, 86105A, 86105B, 86106A, 86106B, 86107A, 86109A, 86109B, 86111A, 86111U, 86112A, 86113A, 86115B, 86116A, 86116B, 86117A, 86117B, 86118A
Product Options:	This declaration covers all options of the above products.
Is in conformity with:	
Safety:	IEC 61010-1:1990 +A1:1992+A2:1995 / EN 61010-1:1994+A2:1995 CAN/CSA-C22.2 No. 1010.1-92
EMC:	CISPR 11:1990/EN 55011:1991 Group 1, Class A IEC 61000-4-2:1995+A1:1998 / EN 61000-4-2:1995, 4 kV CD, 8 kV AD IEC 61000-4-3:1995 / EN 61000-4-3:1995, 3 V/m, 80-1000 MHz IEC 61000-4-4:1995 / EN 61000-4-4:1995, 0.5 kV sig. lines, 1 kV pow. lines IEC 61000-4-5:1995 / EN 61000-4-5:1995, 0.5 kV I-I, 1 kV I-e IEC 61000-4-6:1996 / EN 61000-4-6:1996, 3V 80% AM, power line IEC 61000-4-11:1994 / EN 61000-4-11:1994, 100 %, 20 ms
Supplementary Information:	
The products herewith comply with the requirements of the Low Voltage Directive 73/23/EEC and the EMC Directive 89/336/EEC and carry the CE-marking accordingly.	
	
Santa Rosa, CA, USA	09 September 2002
Greg Pfeiffer/Quality Engineering Manager	
For further information, please contact your local Agilent Technologies sales office, agent or distributor.	

Numerics

12 GHz trigger bandwidth, 1–6
5475x series plug-in modules, 3–11
8348x series plug-in modules, 3–11

A

accessories
 connecting, 1–11
adapters
 APC 3.5 (f-f), 1–7
 SMA (f-f), 1–7
Add Printer Wizard, 1–18
Agilent
 Web site, 1–29
Agilent offices, 1–43
algorithms, 4–7
amplitude offset, 3–10
amplitude scale, 3–10
Applications menu, 3–18
Autoscale button, 3–7

B

blank screen, 3–14
Book icon, 4–6
built-in information system, 4–2
 temporarily hiding, 4–8

C

calibration
 module, 1–26
calibration certificate, 1–6
care of fiber optics, 1–24, 3–11
CE mark, 1–4
cleaning, 1–3
 adapters, 1–38
 fiber-optic connections, 1–30, 1–37
 non-lensed connectors, 1–37
clock signal, 3–7
compressed dust remover, 1–37
connecting
 accessories, 1–11
 printer, 1–12
connector
 care, 1–30
Contents topic, 4–2

contents topic, 4–3
cotton swabs, 1–37
CSA mark, 1–4

D

dialog box
 making transparent, 3–15
 moving, 3–15
dialog boxes, 4–6
dimensions, 1–10
dust caps, 1–37

E

electrical channel input circuits, 1–26
electrostatic discharge, 1–26
Eye/Mask Mode, 3–2, 3–7

F

fiber optics
 care of, 1–24, 3–11
 cleaning connections, 1–30
 connectors, covering, 1–40
fiber-optic adapters, 1–8
File menu, 3–16
file sharing, 1–23
foam swabs, 1–37
front panel
 power switch, 1–24

H

hard drive recovery, 1–42
help, 4–2
help language, selecting, 4–10
help topic, printing, 4–9

I

input
 connector, 1–30
instrument
 checking the shipment, 1–5
 positioning, 1–11
 powering up, 1–24
 returning for service, 1–39

Index

instrument modes, 3-2
ISM1-A, 1-4
isopropyl alcohol, 1-37

K

keyboard, 1-6, 1-11

L

LAN, 1-23
language version, 4-10
line cords, 1-13
line power
 requirements, 1-15

M

Measure menu, 3-17
measurement channels, 3-10
measurement results, 4-7
measurement toolbar, 3-3
measurement toolbars, 3-7, 3-8, 3-9
menu
 bar, 3-16
Minimize button, 4-8
module calibration, 1-26
module, installing, 3-10
modules, installing, 1-9
mouse, 1-6, 1-11

N

network printers, 1-23
network setup, 1-23
noise declaration, 5-2

O

online help, 4-2
Options menu, 3-19
Oscilloscope Mode, 3-2, 3-8

P

package contents, 1-5
packaging for shipment, 1-40
plug-in modules, 3-10

positioning the instrument, 1-11
power
 requirements, 1-15
 switch, 1-24
power switch, 1-15
Print Setup, 1-18
printer
 connecting, 1-12
 printer driver, 1-18, 1-20
 procedures, step-by-step, 4-4

Q

Quick Measure button, 3-13

R

rack mount, 1-6
recovery
 hard drive, 1-42
Restore button, 4-8

S

Safety Class 1 Product, 1-3
sales and service offices, 1-43
service, 1-39
 sales and service offices, 1-43
Setup & Info button, 4-7
shipment, checking package content, 1-5
shipping procedure, 1-39
supported printers, 1-18, 1-20
swabs, 1-37
synchronous clock signal, 3-7

T

TDR/TDT Mode, 3-2, 3-9
time and date, 1-17
time-domain reflectometry, 3-2
timing reference signal, 3-4
touch calibration, 1-22
touch screen, 1-16, 3-3
 configuration, 1-22
 disabling, 3-12
Touch Screen Config, 1-22
trigger input signal, 3-4
Trigger Source button, 3-11

U

Utilities menu, 1-22

W

warm-up time, 1-26

Web site, Agilent, 1-29

weight, 1-10

What's this? icon, 4-6

wire bail, positioning, 1-11

Index